

# Best Selection

2024-2025  
Vol.31

Kitchen, Washroom, Bath, Door & Partition,  
Storage & Interior, Exterior

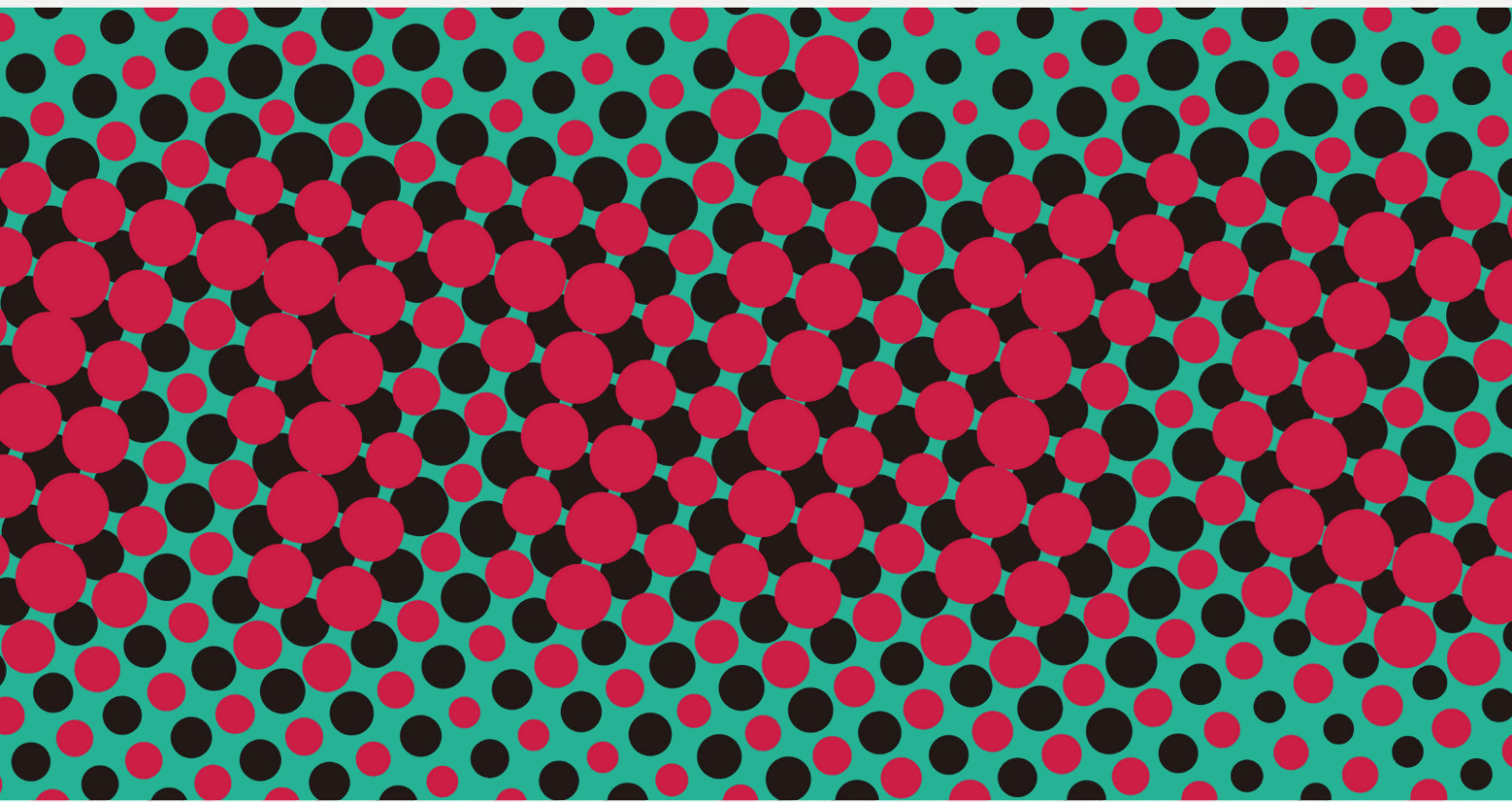

●●● **sanwa**company

くらしを楽しく、美しく。

●●● **sanwa**company

# BRAND PROMISE

**sanwacompany** Brand ensure “A Space that continues to Inspire”

---



●●● **sanwacompany**



1. Company Introduction	▶ 5~10
2. System Kitchen	▶ 11~55
3. Compact Kitchen	▶ 56~77
4. Vanity- Washbowl	▶ 77~156
5. Bath – Door - Storage	▶ 157~199
5. Exterior	▶ 200~213

●●● **sanwa**company

## Company Introduction

Founded in 1979, in Osaka, Japan, **sanwacompany** is a Japanese housing equipment and building materials company with an in-house design team and an e-commerce website.

We provide a variety of household appliances for personalizing your space, such as kitchens, washbasins, baths, fixtures, and exterior housing materials as well as building materials such as tiles, bricks, flooring, natural stones, and glass.

**sanwacompany's** original products are developed around the design concept of "minimalism" have a high international reputation and have garnered numerous design awards.

- **Company name:** sanwacompany ltd.
- **Address:** 21F, 19-19, Chayamachi Kita-Ku, Osaka, 530-0013, Japan
- **Founded:** August 22, 1979
- **Website:** <https://info.sanwacompany.co.jp/en/>



## Company Introduction



### Strength 1:

### Internationally Recognized Design

Sophisticated design products are essential to provide a stylish space. Our in-house products that are developed around the design concept of “minimalism” have a high international reputation and have garnered numerous design awards. This includes the “Salone del Mobile. Milano Award” at the Milano Salone International Furniture Fair in 2018, where **sanwacompany** was honored to be the first Asian company to receive the award.

## Company Introduction



WASHROOM



KITCHEN



BATH



DOOR&PARTITION



STONE



EXTERIOR



MATERIAL



WROUGHT IRON



FLOOR & WALL TILE



FLOORING



WOOD DECK



WALL MATERIAL

### Strength 2:

### Variety of Products for Total Coordination of Your Space

sanwacompany offers a wide selection of products for personalizing your space, many of which are rarely seen in typical houses built for sale. Our main lines are modular kitchens, washbasins, baths, and other products all developed in-house, as well as products selected from manufacturers all over the world to be sold exclusively through sanwacompany.

## Company Introduction



※Especially in Japan

### Strength 3:

## Innovating the Industry with “One Price” for All Customers

We have defied conventions of the general building industry by offering products at the same price under the same conditions regardless of who purchases them, bypassing intermediaries that increase costs.

By simplifying the complicated distribution process, we eliminate the ambiguity in sales price, offer easy-to-understand pricing and reasonably process high-quality products.



## Company Introduction



## Exhibition at Milano Salone

The largest international furniture trade fair in the world, “Salone del Mobile Milano” is held in Milan, Italy. This event not only enhanced our brand value but also provided a trigger for expanding our overseas business. **sanwacompany** exhibited at a biannual event “EuroCucina” (International Kitchen Exhibition) in this fair in 2016 and subsequent 2018, presenting sanwacompany brand to the world.



★ JAPAN

Head Office  
**sanwacompany ltd.**

Address:  
19-19-21F, Chayamachi Kita-Ku, Osaka, 530-0013, Japan  
Website: <https://info.sanwacompany.co.jp/en/>  
Mail: [global@sanwacompany.co.jp](mailto:global@sanwacompany.co.jp)

★ INDONESIA

Distributor  
**PT.HOU-TECH TRADING**

Tel: +62 813 3456 7412  
Address: RUKAN GOLF ISLAND BLOK I  
NO.2 Jalan Pulau Maju Besama Pantai, Indah Kapuk Penjaringan,  
Jakarta Utama, DKI Jakarta 14470  
Mail: [saktyrajasa@gmail.com](mailto:saktyrajasa@gmail.com)

★ USA

Branch  
**sanwacompany USA Inc.**

Address:  
21221 S Western Ave UNIT 215, Torrance, CA 90501  
Mail: [global@sanwacompany.co.jp](mailto:global@sanwacompany.co.jp)

Distributor  
**NIKKA U.S.A. CORP.**

Address: <showroom>  
18541 Hawthorne Blvd. Torrance, CA 90501  
Tel: +1 310 616-5211

★ TAIWAN

Distributor  
**Watanabe Pipe Taiwan Co., LTD**

Address:  
7F.-4, No.141, Sec. 1, Keelung Rd., Xinyi Dist., Taipei City,  
Tel: +886 2 2768 2929

★ THAILAND

Distributor  
**The Selective Company Ltd.**

Address:  
<office> 637/1 Promphan 1 Building, 4th Floor (406-407), Lat Phrao  
Road, Chom Phon, Chatuchak, Bangkok 10900  
Tel: +66 0 9 5662 9239  
Website: <https://www.the-selective.co/>  
Mail: [info.theselective@gmail.com](mailto:info.theselective@gmail.com)

★ CHINA

Distributor  
**Hangzhou Sanwu Decoration Technology Ltd.**

Address:  
<showroom> Room1101, Buliding3, 1866 Binxing Road, Changhe  
Subdistrict, Binjiang District, Hangzhou, China  
Tel: +86-571-28923909  
Website: <http://www.sanwacompany.com>

Mail: [info@sanwacompany.com](mailto:info@sanwacompany.com)

**Shanghai Sanwu Architectural Design Co., Ltd.**

Address:  
<showroom> No. 2588, Kaixuan Road, Xuhui District, Shanghai  
Jinheyuejieyuanlifang 3F L302  
Tel:+86 13917732013

**Ningbo Shuiyue Decoration Design Co., Ltd.**

Address:  
<showroom> No. 1529, Xincheng Avenue North Road, Cixi City, Ningbo  
City, Zhejiang Province West Hall 1 F, Building B, Chacha Building  
Tel:+86 13685714444

**Nanjing Weimiao Cheng Trading Co., Ltd.**

Address:  
<showroom> No. 98, Jiangdong Middle Road, Jianye District, Nanjing  
City, Jiangsu Province Jinling International Home Furnishings 3F, C8214  
Tel:+86 13770945566

★ SINGAPORE

Distributor  
**Retro Colony Pte Ltd.**

Address:  
<showroom> 2nd Floor, 19 Niven Road Singapore 228366  
Tel:+65 6259 2609  
Website: <https://www.retrocolony.com/>  
Mail: [sales@retrocolony.com](mailto:sales@retrocolony.com)

★ PHILIPPINES

Distributor  
**Kanrinmaru-Zp General Merchandise (Fuji Japan Auction)**

Address:  
<office>001 Manly Compound, Unit 84, Brgy. Camalig, Meycauayan,  
Bulacan, Meycauayan, Philippines  
Tel: +63 928 745 2273/ +63 915 202 2089  
Website: <https://www.facebook.com/FUJIJAPANAUCION>  
Mail: [fujijapanauktion@yahoo.com](mailto:fujijapanauktion@yahoo.com)

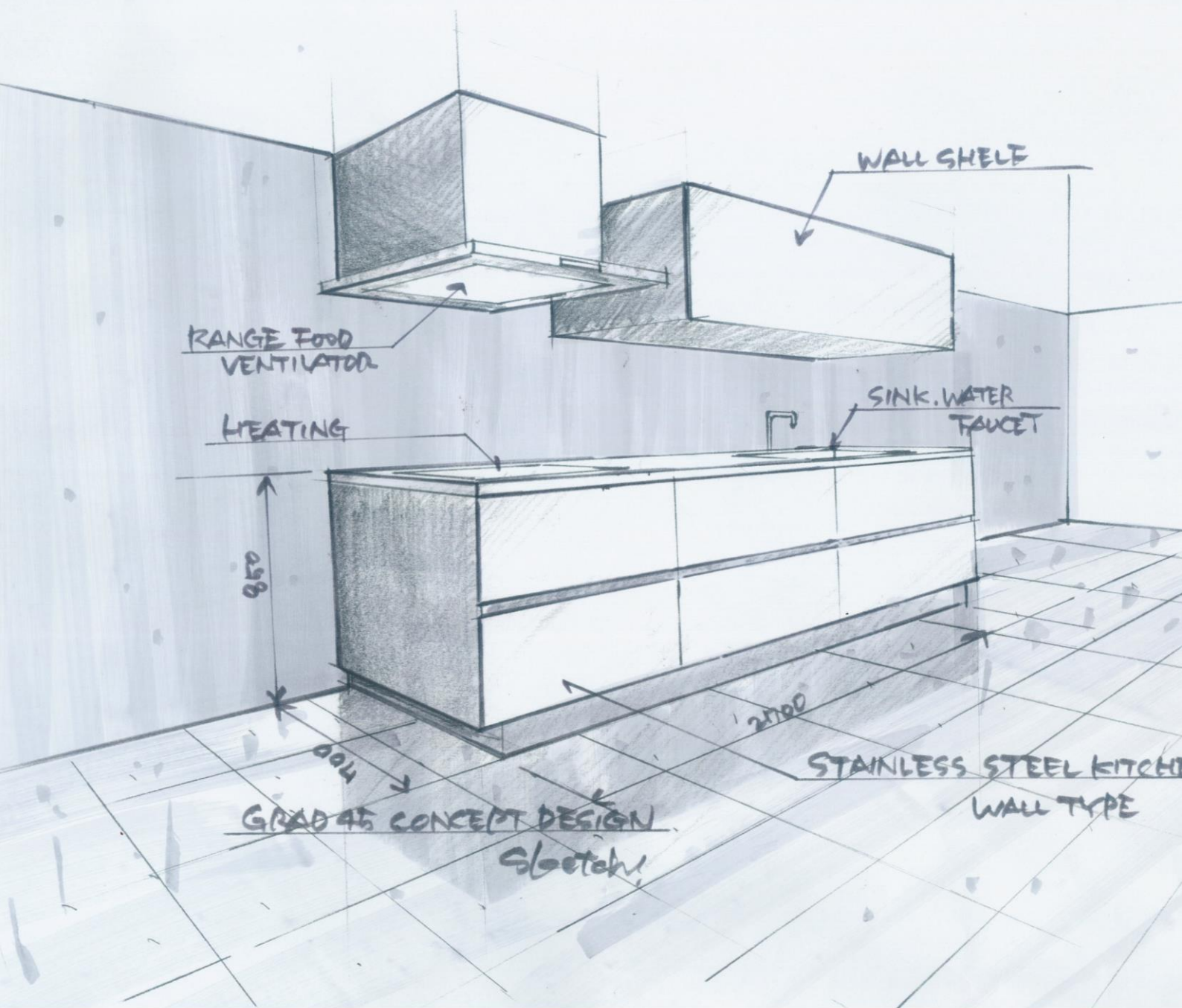

## SYSTEM KITCHEN

●●● sanwacompany

# System Kitchen Line-up



Grad LX



Grad 45



Elevato EX



Elevato



Witte



Osso



Kubire Kitchen



Plain-K Midium

# Grad LX

| System Kitchen

Made in JAPAN



## **Grad Series top-end model in pursuit of high-quality beauty**

“GRAD LX” is a series that pursues even higher quality beauty in addition to the sophisticated design of “GRAD 45”, which is popular for its all-stainless-steel design.

# Grad LX

| System Kitchen

Made in JAPAN



Ceramic stone  
worktop  
combines beauty  
and functionality



Worktop thickness is only 12mm. By making it as thin as possible, it brings out the black color and gives it a solid impression. It creates a solid impression that accentuates the black color.



Dishwashers of the brand of your choice can be incorporated.



Large capacity drawers for pots, bowls, seasonings, etc. are equipped with silent rails that open and close quietly.



A stylish square-corner stainless sink that showcases Japanese craftsmanship. The sink can be installed on the left side, or on the right side.

<b>Size</b>	Width : 2100 · 2400 · 2550 · 2700mm Height : 800 · 850 · 900mm Depth : 650 · 670 · 900mm	
<b>Type</b>	Wall type / island type / peninsula type	
<b>Finishing Touch</b>		Width: 800mm Depth: 190mm Depth: 420mm
	Door leaf	Stainless steel (SUS443J1, acrylic silicone resin coating)
	Base cabinet	Drawer (Silent Rail) Opening (with dining side storage only) / Stainless steel (SUS443J1) hairline
	Wall Cabinet	Flip-up/stainless steel (SUS443J1) hairline

# Kitchen choosing

## 1. Layout

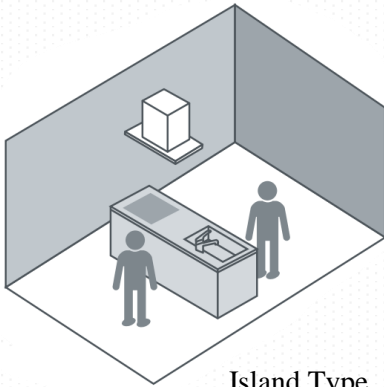

Island Type

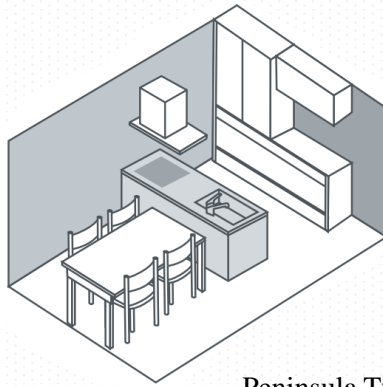

Peninsula Type

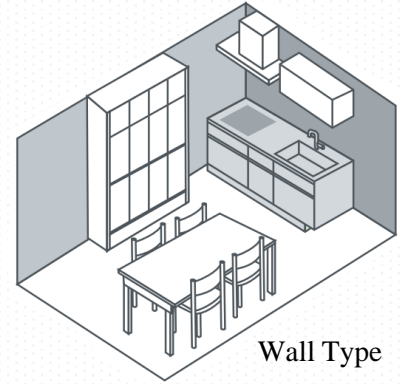

Wall Type

## 2. Plan

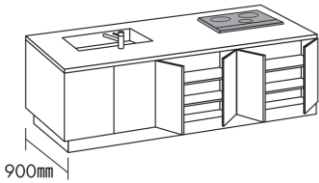

900mm

Island Type	Peninsula Type
W2100mm	W2100mm
W2400mm	W2400mm
W2550mm	W2550mm
W2700mm	W2700mm



Island/ Peninsula Type with front storage

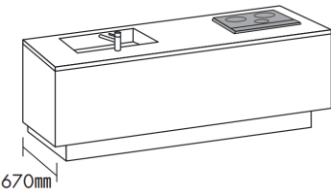

670mm

Island Type	Peninsula Type
W2100mm	W2100mm
W2400mm	W2400mm
W2550mm	W2550mm
W2700mm	W2700mm

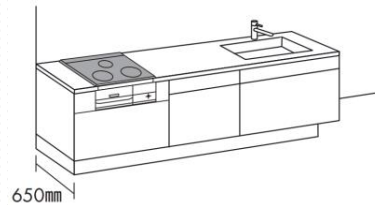

650mm

Wall Type
W2100mm
W2400mm
W2550mm
W2700mm

## 3. Kitchen height

**Ideal kitchen height**

$$(\text{Height}) \div 2 + 2.5 \sim 5\text{cm}$$

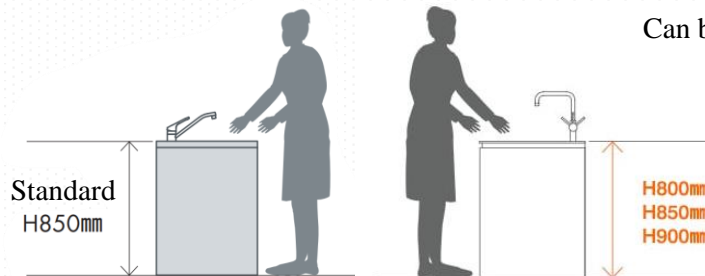

Can be adjusted to 800 or 900mm with additional charge

## 4. Width

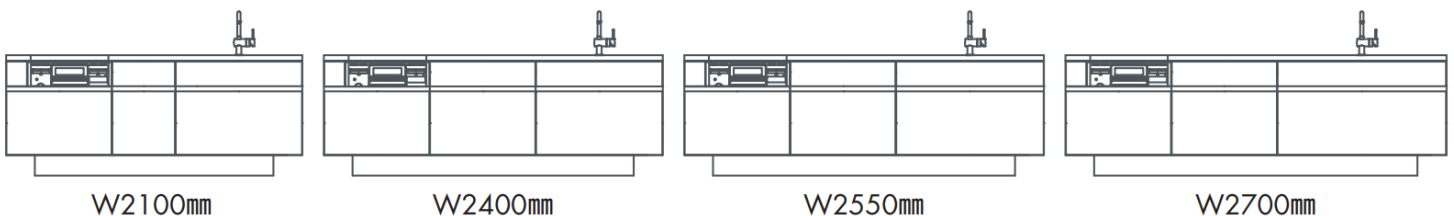

W2100mm

W2400mm

W2550mm

W2700mm



# Grad 45

| System Kitchen

Made in JAPAN



## **A Stainless-steel System Kitchen Combines Functionality with Beauty**

“Grad45” an original system kitchen to enjoy the beauty of all stainless steel, is packed with the commitment of the sanwacompany. This stainless kitchen would change to hi-graded atmosphere in your living space.



## Grad 45

The entire surface is made of stainless steel, and the design is designed to eliminate the waste and highlight the upper texture of the material. The door and side panels are processed so as not to see the small part, and processing is thoroughly taken care of, so that the image is clean and thorough.

### Worktop Finish



Hairline Finish



Vibration Finish

### Kitchen Color



Hairline Finish

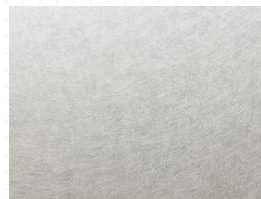

Vibration Finish

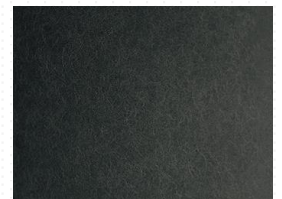

Matte Black Finish

Because it is all stainless steel, it is hard to generate mold and can be used cleanly. In addition, it is possible to select vibration finish or matte black finish as an option, or to incorporate a dishwasher from an overseas manufacturers.

# Grad 45



From the luxurious feel of the stainless steel to the 45° cuts on the corner joints, the attention to detail brings the best of this clean, simple design. Large and easy-to-use designs storage drawers

Fits well with W450/600 dishwasher

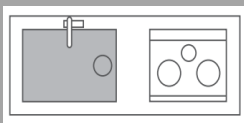

Left side

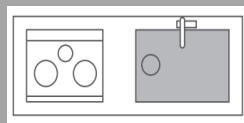

Right side



All-stainless-steel, including front side cabinet. It has a beautiful design like a mirror while having sufficient storage capacity.

A stylish square-corner stainless sink that showcases Japanese craftsmanship. The sink can be installed on the left side, or on the right side.



<b>Size</b>	Width: 1800 (no dishwasher setting), 2100, 2400, 2550, 2700 mm Height: 800/850/900mm Depth: 650/670/850/900mm
<b>Type</b>	Wall type / island type / peninsula type
<b>Worktop</b>	Stainless steel (SUS304) hairline, vibration
<b>Sink</b>	Stainless-steel (SUS304) Hairline /Vibration Finish Damping Sink : (W1800) L:550mm D: 190mm W:420mm (W2100~) L:800mm D: 190mm W:420mm
<b>Finishing touches</b>	Length: 800mm Width: 190mm Depth: 420mm
<b>Door leaf</b>	Hairline: Stainless steel (SUS443J1) Vibration: Stainless steel (SUS304) Black color: Stainless steel (SUS443J1, acrylic silicon resin coating)
<b>Base cabinet</b>	Drawer (Silent Rail) Opening (with dining side storage only) Stainless steel (SUS443J1) hairline
<b>Wall Cabinet</b>	Flip-up/stainless steel (SUS443J1) hairline

**Option**

Faucet



Cooker

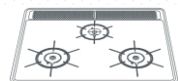

Gas cooker



IH cooker

Flexible install surfaces for Induction or Gas cooker

Range hood



Dishwasher



Wall Cabinet



**Grad 45 Cupboard**

made in Japan



# Kitchen choosing

## 1. Layout

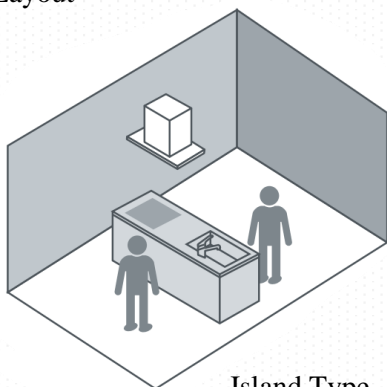

Island Type

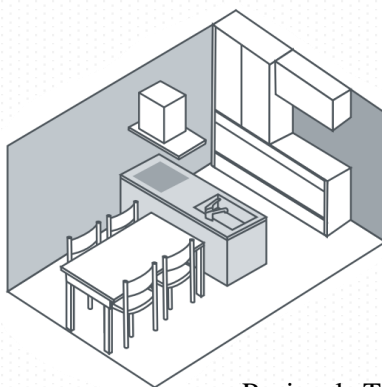

Peninsula Type

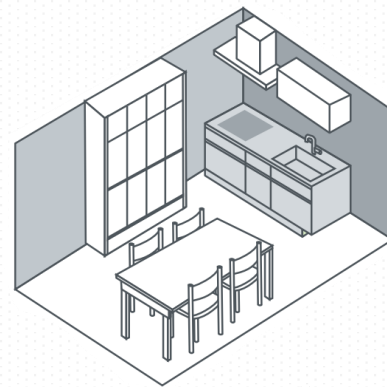

Wall Type

## 2. Plan

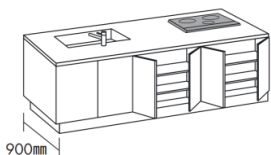

With Back wall Double-Door Cabinets

Island Type	Peninsula Type
W2100mm	W2100mm
W2400mm	W2400mm
W2550mm	W2550mm
W2700mm	W2700mm

W2100mm	W2100mm
W2400mm	W2400mm
W2550mm	W2550mm
W2700mm	W2700mm

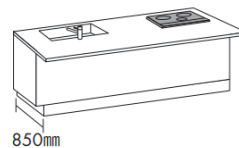

With Counter

Island Type	Peninsula Type
W2100mm	W2100mm
W2400mm	W2400mm
W2550mm	W2550mm
W2700mm	W2700mm

W2100mm	W2100mm
W2400mm	W2400mm
W2550mm	W2550mm
W2700mm	W2700mm

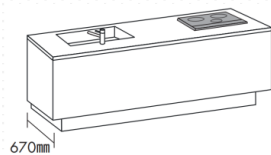

Without Back wall Double-Door Cabinets

Island Type	Peninsula Type
W2100mm	W2100mm
W2400mm	W2400mm
W2550mm	W2550mm
W2700mm	W2700mm

W2100mm	W2100mm
W2400mm	W2400mm
W2550mm	W2550mm
W2700mm	W2700mm

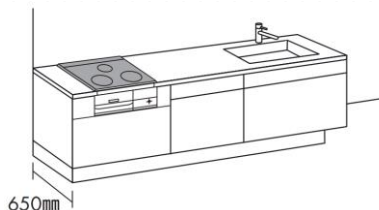

Wall Type
W2100mm
W2400mm
W2550mm
W2700mm

W2100mm
W2400mm
W2550mm
W2700mm

## 3. Kitchen height

**Ideal kitchen height**

$$(\text{Height}) \div 2 + 2.5 \sim 5\text{cm}$$

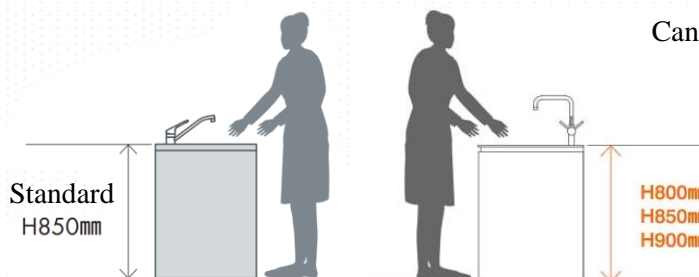

Can be adjusted to 800 or 900mm with additional charge

## 4. Width

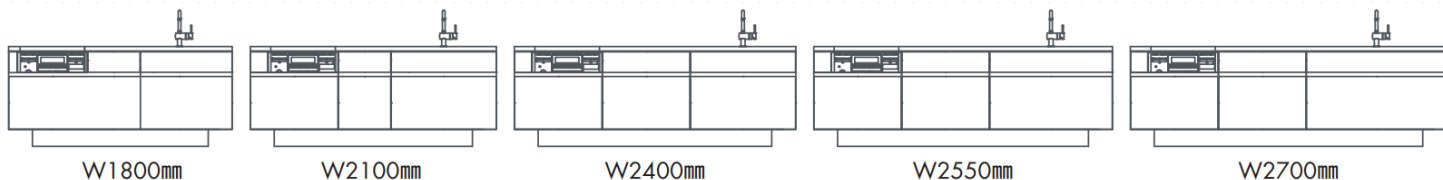

# Construction Portfolio

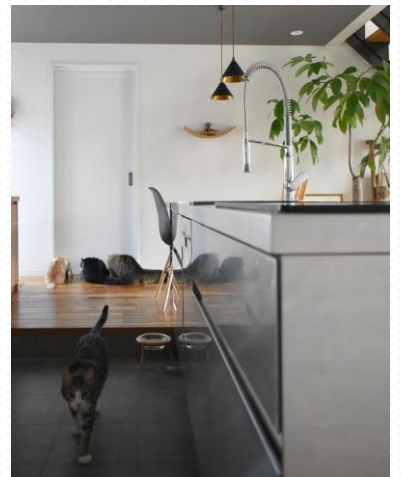

# Construction Portfolio



# Witte

| System Kitchen

- Made in Japan
- ©Made to order
- Size can be specified
- Lead time : 2month~

## From a showing-off to an attractive kitchen

"Witte" has achieved high design at a price range that is easy for many people to reach.



While valuing the realistic texture, we are particular about the beauty of the details and finished it in the ultimate minimal design with outstanding edges. The floating style floats in the air creating a lightness that doesn't become too heavy. It is a kitchen that will become the standard in the future, sublimating the Living-Dining-Kitchen room into a space that people want to gaze at.





**12 color variations in pursuit of a realistic texture**

The main body of the kitchen is available in 6 colors that express a solid feeling like mortar, an aging feeling like rusted metal, and aged wood grain. The handle and architrave are available in two colors: silver and black for a sharper impression. Please enjoy the coordination that matches the interior by combining them freely.

**Kitchen Color**



Cement Silver



Metal Black



White



Allegro Wood



Cafe Wood



Gray wood

**Handle • Plinth Color**



Silver

Black

**Worktop Finish**



Hairline

Vibration



1



2



3



4

**1. Square sink**

The sink also pursues a minimal design. It has a stylish finish with a square form that suppresses the roundness of the corners.

**2. Storage cabinets on the both front and back side**

In the face-to-face plan, we have a 915 mm depth type with a storage space on the dining side..

**3. Fastening process to create sharp edges**

The corners are cut at an angle of 45 degrees and welding joint together to create a beautiful edge while consolidating the lines into a single line.

**4. Sufficient storage space**

The drawers are wide and deep enough to accommodate pots and cooking utensils. Since it can be pulled out by hand, there is no need for a handle, and the appearance is neat.



[Worktop] Stainless steel (SUS304) hairline, vibration  
 [Sink] Stainless steel (SUS304) Hairline/Silent sink/  
 Size: L760 x W410 x D195 mm  
 [Door] Olefin sheet pasted / handle specification  
 [Base cabinet] Drawer (silent rail), opening  
 (dining side storage only: push open)  
 <Exterior> Door same surface material finish  
 <Interior> Decorative perch  
 <Plinth> Silver: PET sheet, Black: Olefin sheet  
 [Wall Cabinet] Opening  
 <Exterior> Door same surface material finish  
 <Interior> Decorative perch  
 [Country of origin] Japan

Option

Faucet



Wide range of products such as shower head faucet or water filter faucet.

Cooker

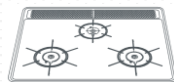

Flexible install surfaces for Induction cooker or Gas cooker

Range hood

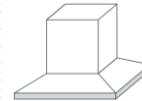

Range hoods with excellent design and full functions for each plan.

Dishwasher

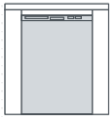

Kitchen Dresser

made in Japan



# Construction Portfolio

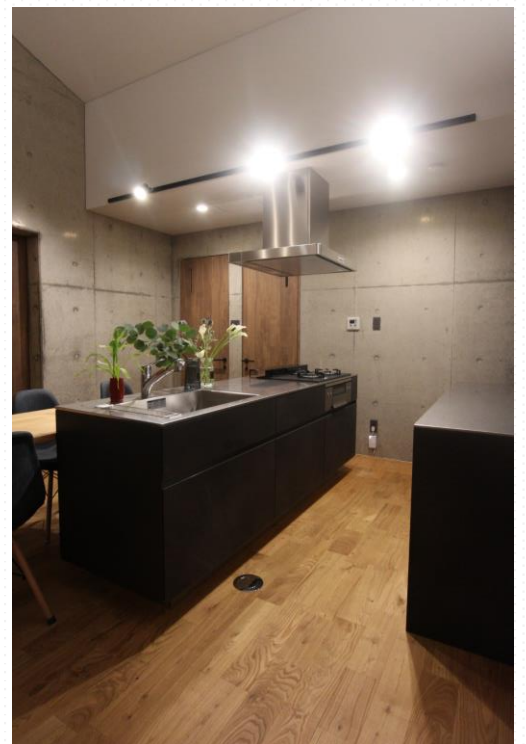

# Elevato EX

| System Kitchen

- **Made in Japan**
- **©Made to order**
- **Size can be specified**
- **Lead time : 2month~**

## **Top model designed to international standards**

The kitchen is equipped with a dining side storage area with plenty of storage space. Cookers, range hoods, dishwashers and etc. can be chosen from world-standard appliances.





# Elevato EX



1. The sink is 80cm wide and has spacious size, making it easy to use. The corners are curved by 10mm, and the drainage is excellent. In addition, the arched side panels and stainless-steel worktop have a unified thickness of 4cm.



2. The standard island and peninsula type has a convenient back of storage cabinets, provides convenient space to display and store dishes, cookbook... When closing the door, it will fit neatly into the interior.

3. Equipped with a hidden integrated outlet  
An outlet is secretly installed in back-of- storage cabinets for more convenient in case using a hot plate or tabletop IH on the dining table.



**Kitchen Color**

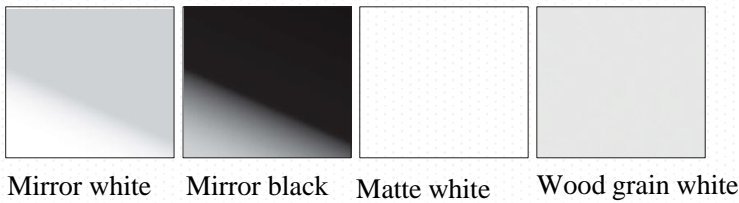

**Worktop Finish**

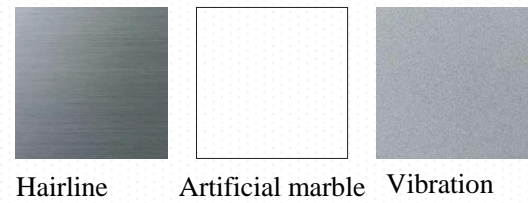

**Option**

**Faucet**

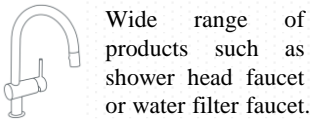

Wide range of products such as shower head faucet or water filter faucet.

**Cooker**

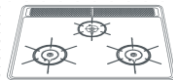

Flexible install surfaces for Induction cooker or Gas cooker

**Range hood**

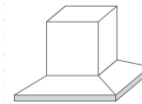

Range hoods with excellent design and full functions for each plan.

**Dishwasher**



- [Worktop] Stainless steel (SUS304) hairline, stainless steel (SUS304) vibration, artificial marble white
- [Sink] Stainless steel (SUS304) Hairline/Silent sink  
Sink size: L800 x 420 x D190mm
- [Door] <Mirror white/Mirror black> PVC sheet attached <Matte white/Wood grain white> Olefin sheet attached/handle specifications
- [Base cabinet] Drawer (silent rail), opening (dining side storage only: push open) / <Exterior> Door same finish <Interior> Color veneer
- [Wall Cabinet] Raised  
<Exterior> Door same finish <Interior> Color veneer
- [Country of origin] Japan





Design by En.Architecture+Design



Design by Live Estate

# Construction Portfolio



Design by Studio Blanc



Design by DECO DESIGN. Co., Ltd.

# Elevato

| System Kitchen

- Made in Japan
- ©Made to order
- Size can be specified
- Lead time : 2month~

## **High-grade model with attention to detail**

A high-end model with attention not only to detail but also to the user experience.

The 6 cm thick stainless-steel worktop and large sink are installed by our highly skilled craftsmen. The storage that uses Blum's soft close drawer rails can be closed quietly and has enough storage capacity to clean up small items around the kitchen. The height of the drawers and materials such as stainless steel and mirror sheets (only the mirror type is used) make it easy to clean the kitchen.







**1. All 6 cm thick stainless-steel worktop is handmade**  
From cutting, bending, welding to polishing, Japanese craftsmen carefully finish each piece.

**Drawer with excellent storage capacity**

In addition to the inner drawer that makes good use of dead space, the worktop is equipped with a small drawer for cutlery (knives, forks, spoons) and chopsticks

**2. Highly acclaimed by professionals, the spacious sink is craftsmanship**

The 80 cm wide square sink was made by a craftsman who produces professional kitchens, and the craftsmanship shines.



### 30 cm high plinth for convenience

The plinth is made 30 cm to become a shallow drawer storage. This reduces the forward bending angle of the person who cooks every day and reduces the burden on the lower back.

### Kitchen Color



Mirror white    Mirror black    Matte white    Wood grain white

### Worktop Finish

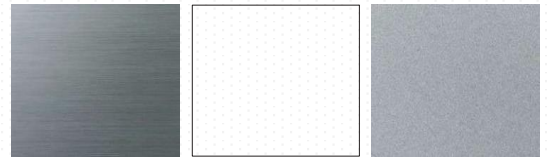

Hairline    Artificial marble    Vibration

### Option

#### Faucet



Wide range of products such as shower head faucet or water filter faucet.

#### Cooker

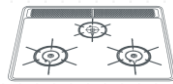

Flexible install surfaces for Induction cooker or Gas cooker

#### Range hood



Range hoods with excellent design and full functions for each plan.

#### Dishwasher



[Worktop] Stainless steel (SUS304) hairline, stainless steel (SUS304) vibration, artificial marble white  
 [Sink] Stainless steel (SUS304) Hairline/Silent sink  
 Sink size: L800 x W420 x D190 mm  
 [Door] <Mirror white/Mirror black> PVC sheet attached  
 <Matte white/Wood grain white> Olefin sheet attached/handle specification  
 [Base cabinet] Drawer (silent rail)  
 <Exterior> Door same finish <Interior> Color veneer  
 <Baseboard> Stainless steel (SUS304) hairline  
 [Wall Cabinet] Raised  
 <Exterior> Door same finish <Interior> Color veneer  
 [Country of origin] Japan

# OSSO

| System Kitchen

- Made in Japan
- ©Made to order
- Size can be specified
- Lead time : 2month~

## Simple form stands out

### All stainless steel\* frame kitchen

The simple design with the minimum necessary functions makes the kitchen look sleek and sophisticated. It is also attractive that you can arrange it according to your lifestyle, such as adding shelf boards and installing storage. Also, in addition to the stain-resistant stainless steel, the breathability and ease of cleaning unique to the frame kitchen allow you to keep it clean at any time. It is a kitchen with a high interior quality that meets the needs of users.







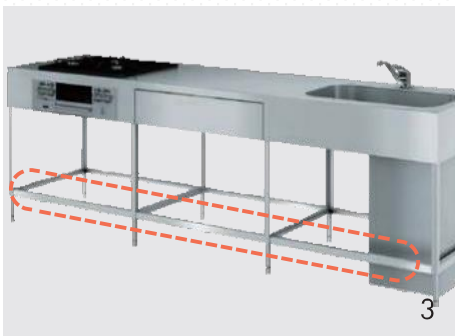
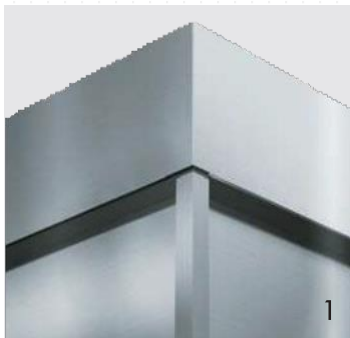

## 1. Sophisticated all-stainless

The material is stainless steel with a sense of luxury and cleanliness. The hairline finish moderates the luster and gives it a more sophisticated impression.

## 2. Don't show extra lines

There are no seams or steps between the sharp framework top and the curtain board, giving a clean impression. The texture of stainless steel stands out.

## 3. Removable front frame

You can freely use the space under your feet by removing the frame. \* The parts that can be removed differ depending on the installation type.

## 4. Efficient use of space (optional)

By adding a punching bottom counter, cooking utensils can be neatly stored.





Osso is a fully custom-built stainless steel system kitchen from Japan with various layouts and options to choose from.



[Worktop] Stainless steel (SUS304) hairline  
 [Sink] Stainless steel (SUS304) Hairline/Silent sink/  
 Sink size: <Press> L750 x W400 x D190mm  
 <Handmade> L700 x W420 x D190mm,  
 W1800: L550 x W420 x D190mm  
 [Frame/pipe cover] Stainless steel (SUS443J1) hairline  
 [Drawer] Silent rail  
 [Country of origin] Japan

Option

Faucet



Wide range of products such as shower head faucet or water filter faucet.

Cooker

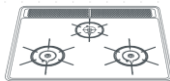

Flexible instal  
 I surfaces for  
 Induction or  
 Gas cooker

Range hood



Range hoods with  
 excellent design and  
 full functions for  
 each plan.

Dishwasher

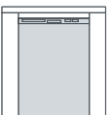

Size

- W1800
- W2100
- W2400
- W2550
- W2700

# Plain-K Medium

| System Kitchen

- Made in Japan / Indonesia (for the US)
- ©Made to order
- Size can be specified
- Lead time : 2month~



## **The culmination of artisan craftsmanship Made in Japan system kitchens**

“Plain K Medium” is an original kitchen featuring large-capacity pull-out storage and simple design.

A variety of options such as IH cooking heater and dishwasher are available for various layouts.

Plain K is a fully custom-built system kitchen from Japan. There are various layouts and options to choose from.



## Plain-K Medium

### Minimalist design is popular for concealed storage

Even in an open, face-to-face layout with no hanging doors, the sleek, handleless door design reduces the sense of domesticity. The cupboard can be combined with a kitchen dresser to provide more than enough storage space.





A range of colors to suit all scenes, from condominiums to detached houses.

A variety of easy-to-use colors are available, including black for a stylish and modern impression and wood grain for a natural and warm space. The 1800mm frontage size is also recommended for condominiums.



### Kitchen Color



White



Black



Brown



Dark Brown



2

**1. All-slide large-capacity storage**

Since the partition plate is removed, pots and bowls can be stored neatly.

**2. High quality & multifunctional sink**

Our experience and history in the production of stainless-steel worktops and sinks tell us about our reliable quality.

**3. Keep an open angle**

The wall cabinet adopts a flip-up type. The door uses a flip-up hinge from Blum (Austria) that can be stopped at any angle.



3





**Single Door Bases**

**Not openable for upper cabinet**

- Cabinets without dishwasher  
W 749 (1800,2100,2400,2550,2700)
- Cabinets with dishwasher  
W 869 (2100), 1049 (2400,2550,2700)
- H 800, 860, 900
- D 600.650, 900

**Single Door Bases**

**Not openable for upper cabinet**

- Cabinets without dishwasher  
W 749 (1800), 869 (2100, 2400), 1019 (2550), 1169 (2700)
- Cabinets with dishwasher  
W 749 (2100), 869 (2400), 1019 (2550), 1169 (2700)
- H 800, 860, 900
- D 600.650, 900



**Single Door Bases**

**Not openable for upper cabinet**

- W 270 (1800 ), 450 (2100), 750 (2400,2550,2700)
- H 800, 860, 900
- D 600.650, 900

**Back wall Double-Door Cabinets**

- W 600, 700, 800, 850, 900
- H 800, 860, 900
- D 600.650, 900

**Worktop Finish**



Hairline

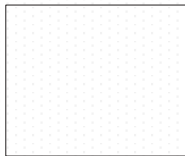

Artificial marble



**Option**

**Faucet**



Wide range of products such as shower head faucet or water filter faucet.

**Cooker**

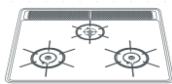

Flexible install surfaces for Gas cooker or Induction

**Range hood**

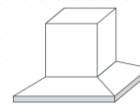

Range hoods with excellent design and full functions for each plan.

**Dishwasher**

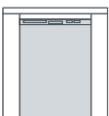

[Worktop] Stainless steel (SUS304) hairline, artificial marble white

[Sink] Stainless steel (SUS304) hairline / Quiet sink (optional) /

With wire pocket sink (W1800 has no pocket sink) /

Sink size: <W1800> W550 x D400 x Depth 190mm

<W2100~> W750 x D360 x Depth 200mm

[Door] Resin veneer/handle specifications

[Base cabinet] Drawer (standard rail/silent rail), Open (only with dining side storage: push open)

<Exterior> Resin veneer <Interior> Color veneer

[Wall cabinet] Raised / <Exterior> Resin veneer <Interior> Color veneer

[Country of origin] Japan



# Kitchen Dresser

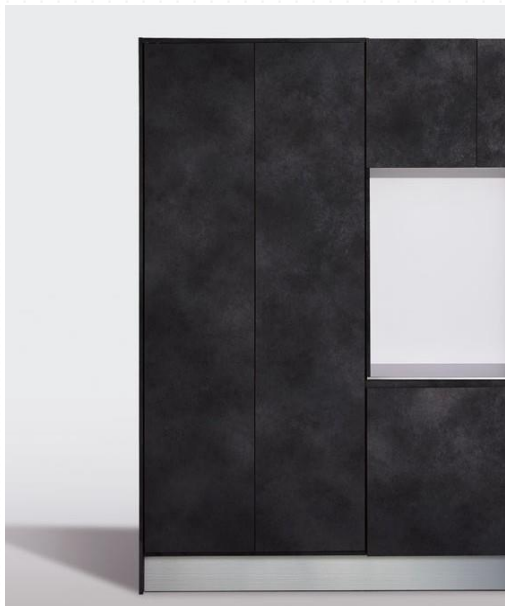

## A Cupboard That Impresses with a Sleek 'Surface'

As the name suggests, the 'Kitchen Dresser' allows you to coordinate your kitchen space with a sense of style. You can achieve the desired storage capacity and ease of use based on the combination of units, and it also caters to your interior design preferences with a variety of surface material options and beautiful finishes. Sanwa Company, aspiring to be the 'Stylist of Spaces,' has prepared this to style each customer's ideal kitchen space.



Combine the 'Grad 45' all-stainless steel system kitchen with a mortar stone color dresser for a modern and stylish space that reduces the sense of everyday life. It's also a trend to intentionally coordinate with a different color from the kitchen unit itself.

A total of 14 color variations are available that can be coordinated with the same color pattern as the system kitchen "Elevato", "Witte", and "Plain K Medium".

EX Class



P Class

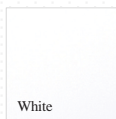

S-1 Class



S-2 Class

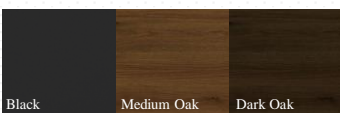

By combining a wide range of units, you can create the perfect cupboard that suits your desired space and functionality.

A variety of unit options are available, including flat and sleek single-door designs and open-style configurations, allowing for a wide range of combinations to be chosen.



**Tall storage**

The single door can be stored in door pocket on both sides. You can normally keep the door stored and easily take items in and out, like an open shelf, and close it when guests visit.

※The choice of having a handle is optional. In the case of no handle, it will be a push latch design.

**Tall single door**

When you open, it will reveal small items storage inside the door. You can conveniently store frequently used kitchen items, such as hanging mittens on hooks or arranging bottles in baskets.

\*Choice of handle available.  
\*Cannot store electrical appliances.



**Opening Undercounter**

We offer the highly requested undercounter open type. It allows you to place a dust box and chairs.

\*Available in separate type, undercounter only type, and tall appliance storage type



A sleek hideaway trash bin wagon.

Equipped with casters, it allows for easy pulling out when using the garbage bin and discreet storage when not in use. It shares the same door material as other cabinets, ensuring a seamless and elegant concealment, keeping your kitchen looking tidy.

\*Available in a sliding counter-equipped open cabinet type and a tall appliance storage open type for your selection.



**Inner Pull-Out Drawer**

The type with a lower pull-out drawer is designed to have two shallow inner pull-out drawers inside the deeper outer drawer, making it convenient for storing frequently used dishes and cutlery. When you open the deeper outer drawer, it is equipped with a synchronized latch that pulls out the top inner drawer as well.

Synchronized latch is included only when selecting Silent Rails.





In the case of P class, it is 1 inner drawer + 1 deep drawer.



**Silent mechanism (hinged door)**  
The door closes slowly, so it is safe even for small children.

\* Only EX, S-1, and S-2 classes are available.  
\* Tall storage does not have a silent mechanism for all classes.

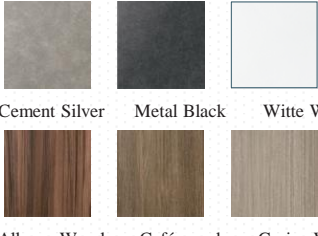
## Class and color variation comparison

Class	Surface color	Material	Features	Stain resistance	Flush Kitchen
EX	 Mirror White    Mirror Black	PVC sheet	High-gloss finish adds a sense of luxury. Glossy white exudes cleanliness, while glossy black offers a sense of sophistication, making it perfect for stylish spaces.	◎	Elevato EX Elevato
S-1	 Mortar Stone    Olive leather	PVC sheet (mortar stone) Olefin seat (olive leather)	The trending mortar-style color adds a modern touch to the living space while toning down the sense of everyday life. Olive leather pairs well with both walls and floors, elevating the space with a sense of sophistication. We recommend using the abundant vertical wood grain patterns of the "Witte" system kitchen, as well as the striking real texture of aged metal in metal black and cement silver as accents.	◎	-
	 Cement Silver    Metal Black    Witte White Allegro Wood    Café wood    Greige Wood	Olefin Sheet			
S-2	 Black    Medium oak    Dark oak	DAP Resin veneer	There is a range of colors to choose from, including sleek and modern black as well as woodgrain patterns that create a warm and natural atmosphere.	○	Plain K Medium
P	 White	DAP Resin veneer	It is a relatively affordable price. The matte finish blends into various spaces and tastes.	△	Plain K Medium

## Reference plan



### S-Class/Mortar Stone Color

Set: Tall storage (without handle) W900, Separate (drawer) W900×2

Size: W2730×D650mm

Worktop: Stainless steel hairline

\* Both side panels are available



### P-Class/White • Silent rail

Set: Tall split door W900, separate (lower base open) W900 Size: W1830×D450mm

Worktop: Stainless steel hairline

\* Both side panels are available



### S-Class/Metal Black

Set: Tall storage (without handle) W900, Separate (drawer) W900, Tall single door W900 Size: W2730×D650mm

Worktop: Stainless steel hairline

\* Both side panels are available

# Grad45 Cupboard



## Elevate Your Kitchen with Stainless Steel Coordination

The "Grad 45 Cupboard" stands out with its all-stainless-steel design. When coordinated with the stainless-steel kitchen "Grad 45," it creates a luxurious kitchen atmosphere. Despite its substantial presence, the panel and doors feature the same 45° edge processing as the kitchen, resulting in a clean and sleek design.

- Wooden materials are used for the countertop backing and cabinet core material.
- Please note that Stainless Steel Black is not available.

Body finish



Hairline

Vibration



A luxurious LDK (Living, Dining, Kitchen) overflowing with an elegant stainless steel-coordinated design.

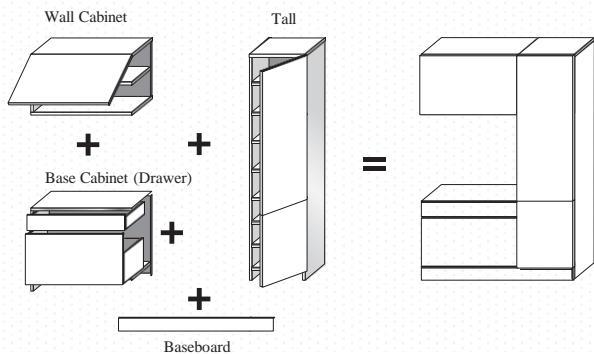

## Customize Doors, Shapes, and Sizes

You can create a functional cupboard tailored to your preferences by choosing the doors, shapes, and sizes, much like ordering custom-made furniture.

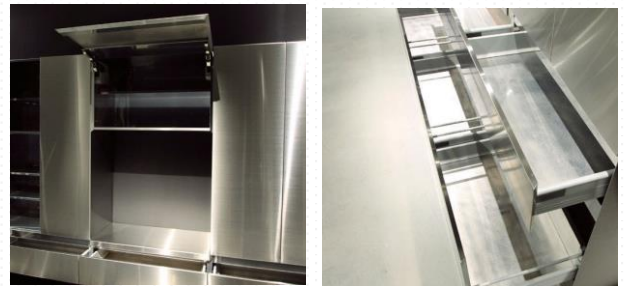

## Two types: "drawer" and "swinging door"

It is a silent specification that does not make a noisy sound when closing both the drawer and the opening door.

They can be seamlessly coordinated with the kitchen. The stainless- steel hairline finish exhibits different expressions based on the angle of light. Wall cabinets come with convenient swing doors. Tall units are equipped with a reassuring earthquake-resistant latch..

# Kitchen Panel

**Original designs featuring a matte, subdued sheen or an aluminum-like texture that are popular**

It is a large-format full-fledged kitchen panel with an original design on a fiber-reinforced cement board. It is light and easy to process, so it is easy to install on site even in a long size. The matte finish and aluminum-like texture will enhance the overall appearance of your kitchen.

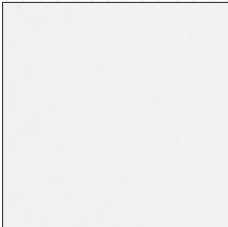

Matte White



Alumina

Kitchen Panel Matte  
White  
WP03231

Kitchen Panels  
Matte White (3×8)  
WP03251

Kitchen Panel Alumina  
WP03139

## Specification

[Base material] fiber-reinforced cement board  
[Surface finish] Dap resin finish (matte white)  
[Finishing coating] acrylic urethane two-component curing type (alumina)  
[Non-combustible certification number] NM-8577  
[Country of origin] Japan



Matte White

Excellent heat resistance and durability combined with high-quality design

The sharp and captivating design that realistically pursues the texture of metal creates a sophisticated space.



Stain



Chrome

## Specification

[Base material] calcium silicate board  
[Finishing coating] acrylic urethane UV  
[Non-combustible certification number] NM-1490  
[Country of origin] Japan

Kitchen Panels  
Luxury (3×6)  
WP11019 Stain  
WP11039 Chrome

Kitchen Panels  
Luxury (3×8)  
WP11059 Stain  
WP11079 Chrome

## Non-combustible wall material from Trend Materials

It is a non-combustible interior decorative board that is resistant to dirt, fading, and heat, and has excellent functionality and design. In addition to the realistic texture of mortar, it has a unique and authentic feel that can create a space full of grade. Because it is thin and light, it can be easily installed with double-sided tape and adhesive, and it has excellent cleanability, so it can be used not only for water areas such as kitchens, but also for living rooms, bedrooms, and commercial facilities. In addition, a small split type are also prepared that is easy to install.

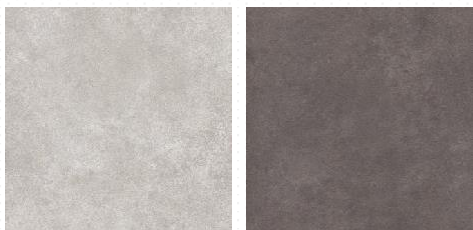

Mortar Light

Mortar Smoke



Aged Metal Black

Aged Metal Brown

Black Slate

Non-combustible material board

WP13569 Mortar Light

WP13579 Mortar Smoke

WP13589 Aged Metal Black

WP13599 Aged Metal Brown

Non-combustible material board small split

WP13649 Mortar Light

WP13659 Mortar Smoke

WP13669 Black Slate

[Base material] fiber-reinforced cement board (non-combustible material board)

Long side: 1C chamfered / painted, short side: thread surface / unpainted (non-combustible material board small split) 1C chamfered on all sides / painted)

[Non-combustible certification number] NM-4238

[Country of origin] Japan

## Non-combustible decorative board that can be used with magnets

Because you can use magnets, you can freely utilize the walls without worrying about drilling holes in the base. It's also easy to wipe away any kitchen mess, making maintenance a breeze.

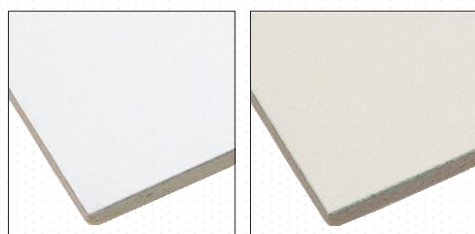

Pearl White

Pearl Beige



Sonic Silver

Champagne Gold

Non-combustible mug board (3×6)  
2Sheets

WP13009 Pearl White

WP13019 Sonic Silver

WP13029 Champagne Gold

Non-combustible mug board  
(3×8)

WP13039 Pearl White

WP13049 Pearl Beige

[Base material] inorganic board + decorative steel plate layer

[Surface finish] Surface film + hard coating (hard coating is only Sonic Silver and Champagne Gold)

\* The material of the inorganic board ... Fiberglass + Rockwool Mixture

\* Rockwool does not use asbestos.

[Non-combustible certification number] NM-4477 (Sonic Silver, Champagne Gold)

NM-2687 (Pearl White, Pearl Beige)

[Country of origin] Japan

※We offer finishing materials to beautifully complete seams and corners.

A black and white photograph of a compact kitchen island. The island is a dark, rectangular block with a stainless steel sink and a modern faucet on top. A black cylindrical object, possibly a coffee maker, sits on the island to the left of the sink. A thin black wire is suspended from the ceiling, forming a geometric shape with three dots at its vertices. The kitchen is set in a minimalist room with white walls and a light-colored tiled floor. On either side of the island, there are woven baskets hanging from a rack on the wall. A white rectangular box with a thin border is centered over the island, containing text.

●●● **sanwa**company  
COMPACT KITCHEN



## Compact Kitchen • Mini Kitchen • Product Line-up



Float Kitchen 430



Grad 45 Compact Kitchen



KNS Compact Kitchen



Metallo



Mortana



Sency



Estico



Compact Kitchen 430



Pattina Compact Kitchen

# Compact Kitchen • Mini Kitchen • Product Line-up



Cotone

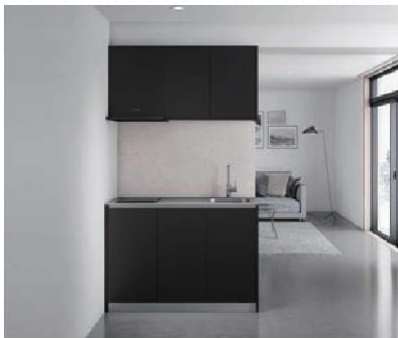

Plain-K Petit



Vano



Minimorous



Rettangoro



Bony



Muji + Kitchen  
Stainless Compact Kitchen



Clasico

# Sency

| Compact Kitchen

made in Japan

Sency made full use of metal texture such as steel and stainless steel. Making the worktop and sides as thin as possible, it turned out in a simple, sharp and sophisticated design. The embossed paint allows a high-quality matt texture of the cabinet, and one cannot easily notice soiling on the surface with a special process.





Flat bar legs (Optional)

1. Achieved through thinning the thickness of the worktop and sides to the extreme thus creating a sleek and modern design composed only of lines and faces. Sency seamlessly fits not only with the modern spaces but also with the trendy industrial ones.

2. The cabinets can be fully extended for easy access, featuring soft-close mechanism for safety. Rail shape specifications are subject to change.



With its lean and simple design, it goes well with not only modern spaces but also trendy industrial spaces.



White



Black

Worktop Finish

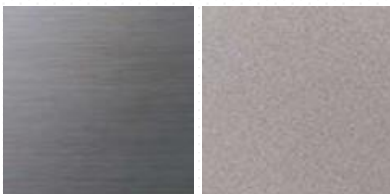

Stainless Hairline Vibration

Sency

Size	Worktop Material
W900	Hairline
W1200	Vibration
W1500	

[Size] W900 · 1200 · 1500 × D600 × H850mm  
 ※ Cabinet height 400 mm  
 [Worktop] Sink integrated stainless-steel, hairline/vibration  
 [Door] Steel plate powder coating (matte finish) / Hand-made specifications  
 [Base Cabinet] Drawer (silent rail)/  
 <Exterior> Steel plate powder coating  
 <Interior> Steel plate powder coating  
 [Flat bar legs ] Stainless steel (SUS304)  
 [Country of origin] Japan

Option

Faucet



Wide range of products such as shower head faucet or water filter faucet.

Cooker



Induction cooker

Range hood



Sency Wall Cabinet



Size	Color
W450	Black
W600	White
W900	

[Size] W450/600/900 x D450 x H400mm  
 [Door] Raised  
 <Exterior> Powder Coated Steel Plate  
 <Interior> Powder Coated Steel Plate, LED lighting  
 [Country of origin] Japan  
 \*Since installation conditions may differ depending on the ordinances of each local government, please contact the local fire department for details.

# Construction Portfolio

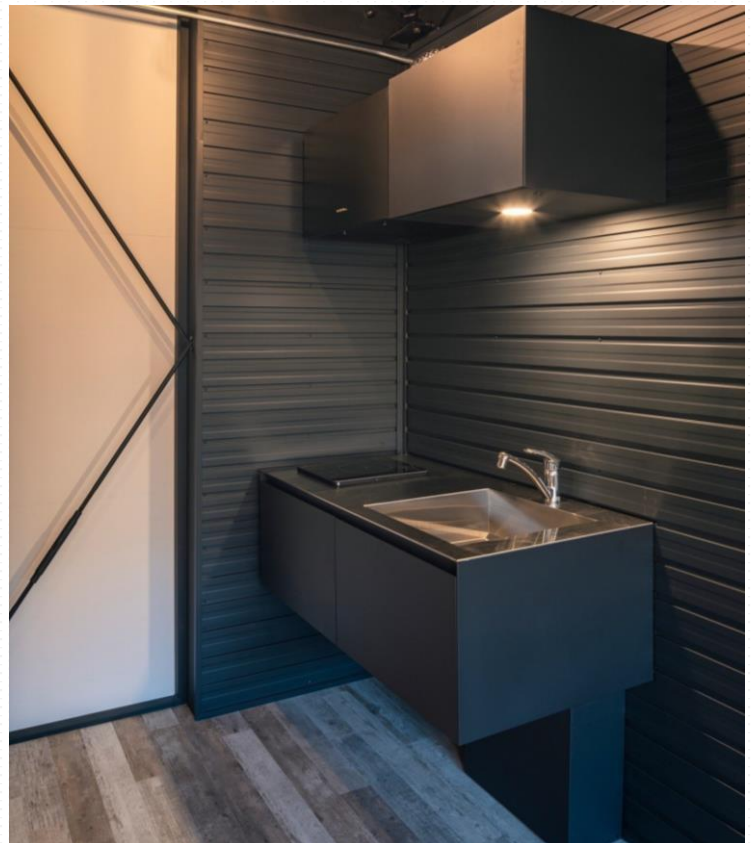
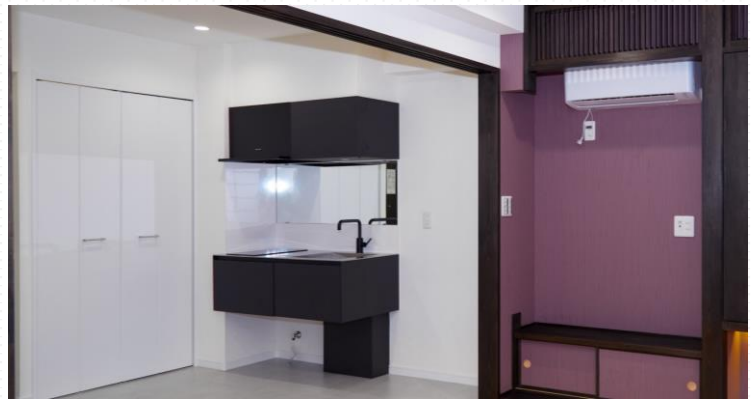

# Mortana

| Compact Kitchen

## Compact mortar kitchen that expresses modern personality

Even if you stick to the space design, you can't find a compact kitchen that harmonizes there. "Mortana" is recommended for designers and rental owners who have such thoughts. A minimal design that reduces the feeling of living by narrowing down only the functions necessary for the kitchen. It can also be used as a sub-kitchen for single-person designer apartments, offices, stores, and two-family homes.





Mortana

Size	Cooktop Cutout
W900	With MOW09EAR/L
	Without MOW09ENR/L
W1150	With MOW11EAR/L
	Without MOW11ENR/L

Option

Faucet



Range food



Plumbing Cover



Cooker



Gas cooker



Induction cooker

1. Stainless steel square sink with fewer rounded corners is crimped from above of the tile worktop plate for a neat fit.
2. The top and side panels are tiled with the same mortar look. The joints have a beautiful finish that does not show the edges due to the "fastening process".

[Size] W900/1150 x D550 x H850mm  
 [Worktop] Porcelain tile  
 [Sink] Stainless steel (SUS304)  
 [Counter auxiliary bracket] Powder Coated Steel Plate  
 [Accessories] Drainage trap, drainage equipment set,  
 Counter auxiliary bracket gray (fixing screw included)  
 [Country of origin] Japan, China

# Rettangoro

| Compact Kitchen

made in Japan

**A minimal kitchen that combines functionality and elegance**  
Rettangoro is an attractive new form that overturns the conventional image of a kitchen. White artificial marble that gives a stylish and clean impression. I used it and pursued a simple design. It is also recommended for a second kitchen such as a bedroom or a bedroom.







Option

Faucet



Cooker



Gas cooker

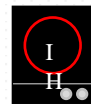

Induction cooker

Range food



[Size] W900/1200 x D450 x H850 mm

[Worktop] Sink-integrated artificial marble matte white

[Piping cover] Made of FRP

[Accessories] Drainage trap (S trap), drainage equipment set

[Country of origin] Japan

# Minimorous

| Compact Kitchen

made in Japan

## Realization of a free space that is refreshing under your feet

The leg is minimized down as much as possible to have an open space under the worktop. You can put large baskets and storage boxes that normally could not fit in a general kitchen, or you can sit down with a chair to do housework.

Handmade kitchen carefully crafted by skilled craftsmen with stainless steel processing.





Spacious, easy-to-use sink.



The small part in front of the worktop is cut diagonally.



Peninsula type



Wall type





Improving a sleek impression by cutting the edge diagonally so that the top plate looks thin. By adopting a kitchen sink that can be used in a wheelchair and a shallow sink, you can use it smoothly even while sitting in a wheelchair.

Specification
Width: 750/900/1200 / 1500mm
Height: 850mm Depth: 500 / 600mm
Finish: Body Stainless steel (SUS430) No.4
Finish: Top board stainless steel (SUS430) No.4
Load capacity: 20kg

## Example of installation

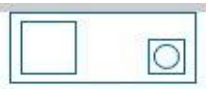
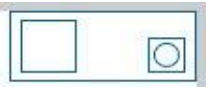
Size	Width: 750/900/1200/1500mm Height: 850 (standard)/750/800/900mm Depth: 500/600mm *Piping cover size varies depending on the selected height.	
Finish	Body	Stainless steel (SUS430) No.4 finish
	Top board	Stainless steel (SUS430) No.4 finish
	Piping cover and water return	Stainless steel (SUS430)
	Triangular stay	Stainless steel (SUS430)
Accessories	<ul style="list-style-type: none"> <li>• Mounting bracket</li> <li>• Drainage trap (shallow type)</li> </ul>	
Load capacity	20kg	

« Wall Mounting Surface »		« Side finish »
Back only		Left and right: Triangular stay
Right wall		Left: Triangular stay Right: L-shaped angle (with side wall)
Left wall		Left: L-shaped angle (with side wall) Right: Triangular stay
Left and right wall mounting		Left and right: L-shaped angle (with side wall)

- You can choose left or right of the sink.
- You can also choose without a faucet opening (flat) or without a heating device opening (flat).
- For W1200 and W1500, a triangular stay is also included in the center.

◆ Option:



Piping cover (for floor extension)

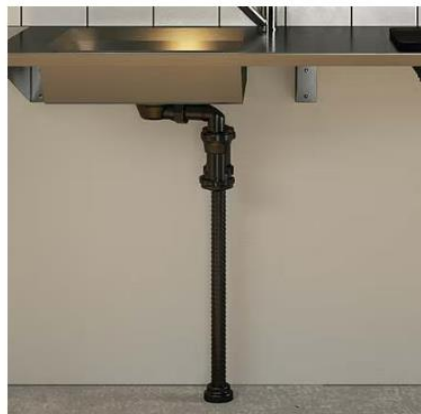

Black Drain Trap Set



Back board

# Compact Kitchen 430

| Compact Kitchen

made in Japan

With the image of a stainless-steel box, we have pursued a simple design by eliminating the handles that give a feeling of unevenness. This is a stainless-steel kitchen that has won the Good Design Award for its "minimal style," which eliminates waste to the limit. It is easy to adapt to the background, and the layout and layout can be expanded.





Material stainless steel, specifically SUS430 No.4, chosen for its resistance to rust, odor, and dirt, along with easy maintenance. Design work is done by craftsmen even in small areas, and we offer high quality above the price. It is a kitchen that can meet all needs such as designers' condominiums, senior condominiums, and second kitchens.

[Size]  
 Wall mount type: W900/1200/1500 x D600 x H850mm  
 Island type: W900 · 1200 · 1500 × D750 × H850mm  
 [Worktop] Stainless steel (SUS430) No.4 finish  
 [Sink] Stainless steel (SUS430) No.4 finish  
 [Door] Stainless steel (SUS430) No.4 finish/handle specifications  
 [Base Cabinet] Open + Drawer (silent rail)  
 [Country of origin] Japan



Made from sheet metal for slimness and ample storage, offering both compactness and practicality

# Float Kitchen 430

| Compact Kitchen

made in Japan

The waste has been trimmed to the utmost limit and based on the popular «Compact Kitchen 430» with a sleek design, we have finished a design that pursues a more luxurious feel. Not to mention the design, the kitchen is also practical.

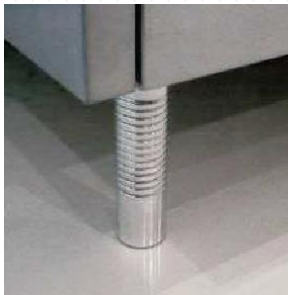

[Size]  
 Wall mount type: W900/1200/1500 x D600 x H850mm  
 Island type: W900 · 1200 · 1500 × D750 × H850mm  
 [Worktop] Stainless steel (SUS430) No.4 finish  
 [Sink] Stainless steel (SUS430) No.4 finish  
 [Door] Stainless steel (SUS430) No.4 finish/handle specifications  
 [Base Cabinet] Drawer (silent rail)  
 [Country of origin] Japan

In order not to feel the weight of stainless steel, the legs are attached and the whole-body floats, creating a sense of openness. The support legs are machined from aluminum, and the spiral groove creates a high-class feel.



## Faucet



Wide range of products such as shower head faucet or water filter faucet.

## Cooker



Gas cooker



Induction cooker

# Grad 45 Compact

| Compact Kitchen

made in Japan

The brand-new compact size of "GRAD 45" is packed with sanwacompany's passion for technology and design.

It realized a renewed design giving a high-class look to the kitchen and paying great attention to details, such as side panels and fastenings not showing the edge of the doors. The vibrant finish of the stainless steel softens the glossy effect thus allowing its blending with different spaces.





The use of special fastenings with the made-in-Japan excellent metal processing technology, as well as the 45-degree cuts at the joint of the drawer and cabinet, provides a beautiful sense of unity that hides small edges.

A stylish sink with sharp corners reflects Sanwa Company's craftsmanship technique. The fine vibrant finish gives a soft expression to stainless steel that obtains the typical texture of traditional Japanese handmade paper.



### Worktop Finish



Stainless Hairline

Vibration (Optional)

### Option

#### Faucet



#### Cooker



Induction cooker



Gas cooker

#### Range food



#### [Size]

Wall type: W1200/1500 x D600 x H850 mm,

Island type/Peninsula type: W1200/1500 x D620/800 x H850 mm

[Worktop] Stainless steel (SUS304) hairline, vibration

[Door] Hairline (SUS443J1), Vibration (SUS304)

[Base Cabinet] Drawer (silent rail)[Sink] Stainless steel (SUS304)

Handmade square sink / Drainage trap shape ø115mm

[Country of origin] Japan



# Plain-K Petit

| Compact Kitchen

made in Japan

"Plane K Petit" yang populer populer tidak hanya karena desainnya yang sederhana, tetapi juga karena banyak pilihan keran dan peralatan pemanasnya.



The non-combustible wall cabinet has plenty of capacity.



Silent hinge standard on base cabinet



The handle on the upper part of the door is a simple shape without a handle.



A kitchen knife holder made of resin that is hard to get dirty. (standard equipment)



An accessory case is standard equipment on the stove side.



Baseboard with stainless hairline

In addition to the clean white color, black has been newly added as a color variation that gives an urban and chic impression.

Black with low gloss tightens the space and harmonizes with modern interiors and furniture. In a one-room apartment or a two-family house, you can achieve a more realistic kitchen space at a reasonable price.



**Finish**



Hairline



Artificial marble

**Cabinet Color**



White



Black

**Pilihan**

**Faucet**



Wide range of products such as shower head faucet or water filter faucet.

**Cooker**



Gas cooker

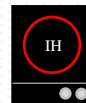

Induction cooker

**Range food**



Size	W900 · 1200 · 1500 · 1800mm H850mm D600mm	
Type	Wall Type	
Color	Door	White, Black
Finishing Touch	Cabinet	<Exterior> Resin veneer <Interior> Color veneer
	Hanging cabinet	<Exterior> Resin veneer (partly incombustible) <Interior> Color veneer
	Worktop	Stainless Steel (SUS304) Hairline
	Sink	Stainless Steel (SUS304)

# Cotone - Vano

| Compact Kitchen

made in Japan



# Vano

| Compact Kitchen

made in Japan

Vano is a user-friendly, compact stainless-steel kitchen with easy-to-open doors. Crafted by skilled artisans in a renowned factory with over 50 years of experience in stainless steel processing, it showcases the craftsmanship of artisans who are dedicated to design and material quality. Despite being a masterpiece that shines with artisanal skill and attention to detail, it also boasts an attractive price point.



## Stylish all-stainless ultra-compact kitchen

Stylish all-stainless ultra-compact kitchen with square corner sink crafted by stainless artisans, featuring a sharp design that fits any space.

- ※ Wood is used for the underside of the countertop.
- ※ Sink can be switched to the left or right side.

Size	W450/750/900x D450 x H850mm	
Sink Size	W300 x D300 x H180mm	
Finishing	Main body	Stainless steel SUS430 No.4
	Worktop/Sink	Stainless steel SUS430 No.4
	Door	Stainless steel (SUS430)
Country of origin	Japan	



\*With soft close door that closes quietly

\*Faucet is not included.  $\phi$ 36mm opening only.

# Clasico

| Compact Kitchen

made in Japan





# VANITY

---

●●● **sanwa**company

# Sency

| Vanity

made in Japan

Sency Vanity is a vanity utilizing the processing technology and materials known for its performance in the automobile industry developed into household appliances.



Vanity - Sency



# SENCY VANITY



Option drainage cover

Taking full advantage of Japan's sheet metal working and welding techniques, the body does not use a single screw, and a sharp design was realized by minimizing the thickness of the worktop and the side panels.



The embossed satin finishing coat reduces diffused reflection, giving a fine matte look as well as a forgiving feature for hiding stains.

The minimal and clean design will fit not only a modern interior, but also the trendy industrial look.

## Color

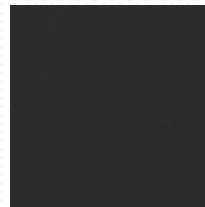

Black

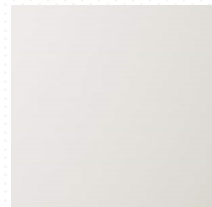

White



Size	Width	600 · 750 · 900mm
	Height	400mm * Top plate height when pipe cover is installed: 800 to 900 mm * Top plate height when legs are installed: 850 mm
	Depth	550mm
Color	Black, White	
Finishing touch	Worktop	Stainless-steel (SUS304)
	Bowl	Faucet mounting hole : $\phi 36$ mm
	Cabinet	Steel plate powder coating
Accessories	Dedicated perforated plate/perforated plate cover *Mirror, faucet, drain fitting, and stopcock are not included.	



# SENCY VANITY



## Features

- Water-resistant hybrid coating with an attractive matte texture
- Neat storage while maintaining design aesthetics
- The bowl features a stainless-steel construction with a high hardness, excellent resistance to staining, and weather resistance, achieved through an inorganic + organic hybrid coating.

## ■ Size



W600

W750

W900

## ■ Faucet Option



New Vega  
Mixing faucet white  
(TA05129N)

New Vega  
Mixing faucet black  
(TA05139N)

New Vega  
Mixing faucet chrome  
(TA01699N)

Single faucet  
(TA01159)

## ■ Plumbing Cover Option

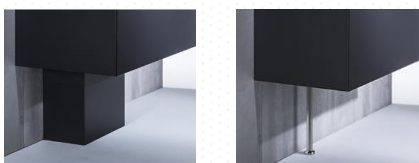

With

Without

## ■ Drainage traps



Silver  
(WA00231)

Matte Black  
(WA00381)

## ■ Flooring type stop plugs



Standing Water Supply Line with Stop valve  
(TA04099/360-585mm)

# Plain-V

| Vanity

made in Japan

An all-in-one vanity unit featuring a faucet, mirror box, and drainage equipment. The generously sized deep bowl, integrated into the countertop made of artificial marble, complements the matte finish of the entire cabinet by keeping the gloss restrained. Available in two colors, White, which matches any space, and Black, enhancing a modern impression



# Plain-V VANITY



Hinged door type White



Drawer Type: White



Hinged Door Type Black



Drawer Type: Black

Washroom

## Plain-V White

Size	Type	Code
W600 (One-sided mirror)	Hinged Door	PLVH10FWHL
	Drawer	PLVS10FWHL
W750 (Two-sided mirror)	Hinged Door	PLVH20FWHL
	Drawer	PLVS20FWHL
W900 (Three-sided mirror)	Hinged Door	PLVH30FWHL
	Drawer	PLVS30FWHL
W1200 (Three-sided mirror)	Hinged Door	PLVH40FWHL
	Drawer	PLVS40FWHL



Compact mixer faucet



Seamless, easy-to-use, deep, bowl-integrated baking sheet

## Plain-V Black

Size	Type	Code
W600 (One-sided mirror)	Hinged Door	PLVH10FBKCL
	Drawer	PLVS10FBKCL
W750 (Two-sided mirror)	Hinged Door	PLVH20FBKCL
	Drawer	PLVS20FBKCL
W900 (Three-sided mirror)	Hinged Door	PLVH30FBKCL
	Drawer	PLVS30FBKCL
W1200 (Three-sided mirror)	Hinged Door	PLVH40FBKCL
	Drawer	PLVS40FBKCL



Clue is a simple shape without a handle



The skirting board is stainless steel, resistant to water.

Option: Cabinet Height Adjustment

[Top plate] Artificial marble with integrated bowl (with overflow)  
 [Size] W600, 750, 900, 1200 × D550 × H750mm  
 [Bowl size] W510 × D360mm Capacity: 16L / Bowl depth: 155mm / Faucet mounting hole diameter: ø36mm  
 [Door] [White] Poly plywood (Black) Dup resin veneer [Base Cabinet] Open, drawer (silent rail) / 〈White〉 (exterior) Door same finish (interior) Color veneer 〈Black〉 (side panel) Dup resin veneer (bottom plate and backboard) Decorative particle board  
 [Water faucet] Linea mixing faucet (hot water saving C1)  
 [Mirror Box] moisture-proof mirror  
 [Country of origin] Japan

Option of faucet (common to hinged door type and drawer type)



# Plain-V Upright

| Vanity

made in Japan

**A higher-grade washbasin that promises "satisfaction"**

Named after the upright piano, this wall-mounted high-back style washbasin stands tall along the wall. It features a deep sink and a shower faucet, which were frequently requested by designers and architects. Its user-friendly design has garnered positive feedback, particularly from large families.



Drawer type White W900 Wall tiles: Brick Glossy White

# Plain-V VANITY



Hinged door type White



Drawer Type: White



Hinged Door Type Black



Drawer Type: Black

## Plain V-Upright White

Size	Type	Code
W600 (One-sided mirror)	Hinged Door	PLVU10W
	Drawer	PLVUS10W
W750 (Two-sided mirror)	Hinged Door	PLVU20W
	Drawer	PLVUS20W
W900 (Three-sided mirror)	Hinged Door	PLVU30W
	Drawer	PLVUS30W
W1200 (Three-sided mirror)	Hinged Door	PLVU40W
	Drawer	PLVUS40W

## Plain V upright black

Size	Type	Code
W600 (One-sided mirror)	Hinged Door	PLVU10B
	Drawer	PLVUS10B
W750 (Two-sided mirror)	Hinged Door	PLVU20B
	Drawer	PLVUS20B
W900 (Three-sided mirror)	Hinged Door	PLVU30B
	Drawer	PLVUS30B
W1200 (Three-sided mirror)	Hinged Door	PLVU40B
	Drawer	PLVUS40B



The depth of the rise is 7 cm. Cups and hand soap can be placed.



Shower mixer faucet is standard equipment. The artificial marble top is one-piece and has no gaps, making it easy to clean.

[Size] W600, 750, 900, 1200×D550×H955 (Cabinet 755 + High Back 200) mm  
 [Top plate] Artificial marble with integrated bowl (with overflow)  
 [Bowl size] W500×D480mm Capacity: 16.7L /  
 Faucet mounting hole diameter: ø46mm (2 places)  
 [Door] [White] Poly plywood (Black) Dup resin veneer  
 [Base cabinet] opening, drawer (silent rail) /  
 〈White〉 (exterior) door finish (interior) color veneer  
 〈Black〉 ( Side panel) Dap resin decorative board (bottom plate / back plate)  
 Decorative particle board  
 [Water faucet] Single lever mixer faucet with wall with shower (hot water saving C1)  
 [Mirror box] moisture-proof mirror  
 [Country of origin] Japan

# Fine

| Vanity

made in Japan

“Fine” is a wash-stand whose frame design is the concept.

The thin frame of the stand and the matching mirror maximize the sense of space in your bathroom.



Vanity – Fine



Because all of the screws are hidden within the design, Fine looks very simple and neat. Delivery is easier and the ultra-thin design allows for plenty of work-space while your bathroom is being installed.

There are two choices of color for Fine bowl, Gray or white.

The shelf board and drawer come in 2 color of black and white, allowing you to coordinate to suit your own personal taste.

## Fine Mirror

These mirrors from the same series can be coordinated to create a sense of unity.



White 600



Black 450

## Features of Fine wash basin



### The frame

Design gives a light and sharp impression. You can hang towels etc. on the front frame.



### Bowl (Top Plate)

The sink bowl with integrated top plate has a smooth curve and is designed with attention to detail for ease of cleaning.



### Storage (drawer)

Slide rail with push-open. Simply press the front plate to open the drawer.

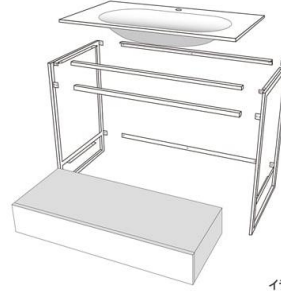

イラストはイ

### Easy-to-assemble

Fine Vanity can be easily assembled on-site. The compact package makes it easy to transport and store materials.



W600



W750



W900

### Countertop/Sink Color

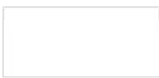

a. White



b. Gray

### Frame/ Shelf / Storage (drawer) Color

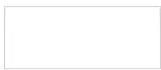

a. White



b. Black

### Fine Mirror

Size	Color	Code
W450	White	PLVH10FBKL
	Black	PLVS10FBKL
W600	White	PLVH20FBKL
	Black	PLVS20FBKL



<b>Size</b>	Width: 600/750/900mm Height: 800mm Depth: 500mm	
<b>Type</b>	Shelf board / storage (drawer)	
<b>Color</b>	Bowl (top plate)	White, Gray
	Flame	White, Black
	Shelf board	White, Black
	Storage (drawer)	White, Black
<b>Finish</b>	Top board	Bowl-integrated polyester artificial marble
	Bowl	No overflow, faucet installation hole: φ36mm, Bowl depth: 120mm Capacity W600: 7.5L W750: 9.5L W900: 12.5L
	Shelf board	Olefin sheet
	Storage (drawer)	Top plate/side plate: Melamine decorative board Door/Others: Olefin sheet

### Faucet fittings



Linea mixer faucet  
TA05299



Fixer Mixing Faucet  
TA01919N Black Matte  
TA01909N White Matte

# Estico Vanity

| Vanity

made in Japan

## Enjoy the minimalist charm of melamine in the washroom

Constructed entirely with melamine, including the doors, tabletop, and side panels, employing a 'locking' technique where joints are mitered at a 45-degree angle to achieve a seamless finish without visible edges. Moreover, the drawers feature a sleek slide-open design, eliminating handles for a cleaner look. True to its name derived from the Italian word 'estetico' meaning aesthetic, this series boasts a minimalist design that enhances the stylishness of any washroom space. Pair it with the kitchen set from the same series for a coordinated ensemble and enjoy the harmonious coordination.







Black 600



Smoky Gray 750

**Estico Vanity**

Size	Color	Code
W600	Black	ESW60KS
	Smoky Gray	ESW60GS
W750	Black	ESW75KS
	Smoky Gray	ESW75GS

[Size] W600, 750× D550×H820mm  
 [Top plate/door] Melamine veneer  
 [Bowl] Stainless steel (SUS430) Paint finish  
 [Maximum bowl depth] 120mm Faucet mounting hole diameter: ø36mm  
 [Capacity] 19L  
 [Base cabinet] drawer (silent rail)  
 [Accessories] eye plate, drainage trap (listed price includes S trap)  
 [Country of origin] Japan

**Faucet fittings**



Fixer Mixing Faucet  
 TA01919N Black Matte  
 TA01909N White Matte



Sut Blend Faucet  
 TA01609



The bowl is painted stainless steel and coordinated in the same color as the face material.



The slide-type storage that can be opened by hanging your hand is easy to take out and has plenty of room.

# Liclair

| Vanity

Create your own sophisticated wash space with your favorite wash bowl and lower stand



Float type black



Drawer type white

Are you seeking to personalize your wash area with your favorite wash bowl and a sleek, minimalist stand? Or perhaps you desire a touch of luxury reminiscent of a high-end hotel?

If you have such a request, the washbasin stand “Liclair” is perfect. Liclair is the ultimate minimal design composed of faces and lines.

The decoration has been trimmed to the utmost so that it fits easily into any washbasin. In addition, it has enough storage capacity to store small items, so you can keep the wash space clean.

There are two offers of wall-mounted units: the 'Float Type,' which appears to float with no visible handles, featuring a flap-down design that opens the door towards you with a push-open mechanism, and the 'Drawer Type,' prioritizing storage capacity with two-tiered drawers for enhanced usability and increased storage space.

#### Float Type



It's a mini marvel of design, appearing as if the cubic 'box' is floating, with no visible seams when viewed from the front.

#### Liclair Float Type

Size	Color	Code
W450	White	WLRF021
	Black	BLRF021
W600	White	WLRF028
	Black	BLRF028



W750 White

#### Drawer Type



The handles are designed to be extremely thin, almost imperceptible when viewed from the front, while considering ease of opening and closing drawers. The drawer rails are located at the bottom of the shelf, making them less visible, and the design ensures a clean and tidy appearance even when the drawers are open.

#### Liclair drawer type

Size	Color	Code
W450	White	WLRS027
	Black	BLRS027
W600	White	WLRS036
	Black	BLRS036



W750 Black

[Size]  
 Float: W750 / 900 × D550 × H365mm  
 Drawers: W750 / 900 × D550 × H690mm  
 [Top plate / door] Float / drawer common: melamine  
 [Side plate] Float: Melamine, Drawer: Olefin finish  
 [Handle] Drawer: Aluminum material  
 [Country of origin] Japan

# Pattina Vanity

| Vanity

Japan

Wood grain × steel legs express a vintage feel

Constructed entirely with melamine, including the doors, tabletop, and side panels, employing a 'locking' technique where joints are mitered at a 45-degree angle to achieve a seamless finish without visible edges. Moreover, the drawers feature a sleek slide-open design, eliminating handles for a cleaner look. True to its name derived from the Italian word 'estetico' meaning aesthetic, this series boasts a minimalist design that enhances the stylishness of any washroom space. Pair it with the kitchen set from the same series for a coordinated ensemble and enjoy the harmonious coordination.



モダンビンテージテイストが魅力の「パティナ洗面台」同シリーズの「パティナコンパクトキッチン」と同じく、木調の面材と黒のフレーム、人工大理石のオーバーボウルで構成しました。デザインはあくまでもシンプルを心がけて素材感を際立たせ、コーナー部の割まりといったディテールの美しさにも配慮しています。床から浮かせたフロアタイプなので空間への圧迫感もありません。水まわりでも、自分好みのインテリア感あふれる空間づくりをお楽しみください。

# Karimoku Vanity

| Vanity

made in Japan

Experience the warmth of high-quality natural solid wood with the **KARIMOKU** collaboration washbasin vanity.

'Karimoku Washbasin', born from a collaboration with the top brand in wooden furniture, Karimoku Furniture. With its three-dimensional deep shadows and the warm wood grain and hues unique to natural solid wood, it creates a luxurious washing space.



●●● sanwacompany

×

**karimoku**

**Karimoku Furniture**

Based in Aichi Prefecture, this top brand of wooden furniture utilizes domestically sourced natural wood. With a solid reputation, it has garnered immense support from a wide range of age groups over the years. With the motto “We would like to create furniture worthy of the growth rings of a century-old tree.,” the brand is dedicated to maximizing the allure of wood and maintaining a steadfast commitment to crafting high-quality furniture.

1. The door is crafted using carefully selected solid oak wood, and is coated with urethane on the door, tabletop, side panels, and interior, providing excellent water repellency and resistance to stains.
2. Easy-to-view open-door design allows for convenient internal visibility. With ample storage capacity, you can enjoy flexible layout options tailored to your convenience.



W800



W1200



1



2

Water faucets, washbasins, drainage hardware, etc. are not included.  
 \* Top plate will be delivered without opening. Please open the top plate on site.

**Karimoku washbasin**

Size	Code
W800	KC0008
W1200	KC0009

[Size] W802, 1202× D550×H690mm  
 [Top plate] Sawn oak plate Urethane coating  
 [Door] Solid oak Urethane coating  
 [Side plate, Interior] Decorative paper Urethane coating  
 [Country of origin] Japan

**Karimo Mirror**

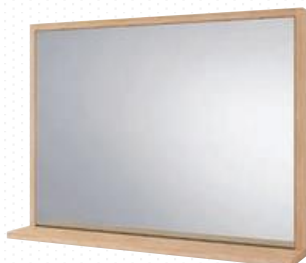

Like the washbasin, it is a luxurious mirror made of solid oak. You can coordinate it with furniture other than the washbasin.

Size	Code
W800	KC00010
W1200	KC00011

# L-form

| Vanity

made in Japan

**High back countertop washbasin with the ultimate in functional beauty**

L-form is a stylish countertop sink. The sink area is stylishly designed by making everything from the back rise to the front fall in a straight line. In addition to its design, it is also easy to clean and functional..





The sink is deep enough (about 17 cm) to provide plenty of space for a large bucket (10-13 liters). It can be used not only for daily hand washing, but also for washing large items. The drain is placed at the end of the bowl so that it does not interfere with washing.



The high-back section is 3.35 inch deep and can be used to place small items or hand soap.

Two colors are available: clean white and trendy gray.

The bowl can be positioned in the center or on either side of the counter for a more spacious countertop.



center



on the right



on the left



A wall-mounted shower faucet that prevents water from pooling around the spout is used.

With its extendable head, it reaches every corner of the bowl, making cleaning easy and comfortable.

[Size] W1200 x D568 x H428 mm  
 \*(W47.24 x D22.36 x H16.85 inch )  
 [Countertop] Artificial marble with integrated bowl (with overflow)  
 White: Matte finish, Gray: Urethane coating  
 Bowl depth: 167mm  
 Capacity: 20L  
 [Country of origin] Japan



# Fioretto Vanity

**Make your washroom look like a luxury hotel**

| Vanity

made in Japan

The Fioretto vanity creates a luxurious space with its solid top and beautiful front drop. The countertop and bowl are seamlessly bonded to create not only a beautiful design, but also an easy to clean surface. Seven colors are available in standard and luxury finishes. A variety of sizes and bowl positions are available to meet a wide range of lifestyle needs.



# Fioretto

**In addition to the on-trend color pattern, a double bowl can also be set**

Among the two grades, 'Standard' offers a range of four colors in the greige palette, while 'Luxuriously' features three colors in high-end, textured stone finishes. Both collections present fresh and trendy color patterns that are popular in contemporary interior design. Additionally, with the W1500 size, it's possible to set up a double bowl configuration, allowing for two bowls side by side. For instance, opting for a double bowl in the 'Luxuriously' collection enhances the rich texture of the stone patterns, creating a truly hotel-like washroom ambiance.



### **One-sided bowl type for wider counters**

The counter width is available in four sizes: W750, 900, 1200 and 1500.

The position of the bowl can be selected from right-justified or left-justified for the W1200 and 1500 sizes.

The counter can be spaciously used not only for hand washing and dishwashing, but also for make-up spaces, etc.



Artificial marble tabletop made of quartz, which has the texture and feel of natural stone but is resistant to scratches and stains

## Color

### Standard

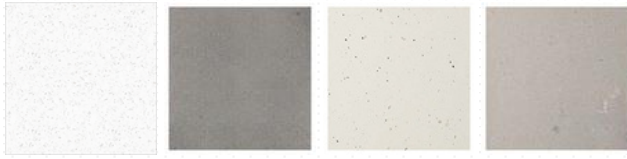

Snow Concrete Powder White Soft Concrete

### Luxury



Bianco Cenere Nero

## Size



W750mm (Snow)



W900mm  
(Concrete)



W1200mm  
(Powder White )



W1500mm  
(Soft Concrete)

## Sink Placement



Center  
(Powder White)



On the left/right  
(only available for W1200 and W1500)



2 sinks  
(only available for W1500)

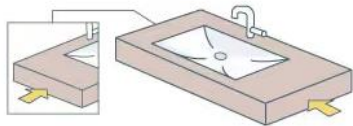

Decorative finish on both sides



One side decorative finish



Without Side decorative Finish

[Size] W750, 900, 1200, 1500 x D600 x H150 mm

\*(W29.53, 35.43, 47.24, 59 x D23.62 x H5.9 mm)

[Countertop] Quartz Engineered Stone (seamlessly bonded with bowl), Faucet hole diameter:  $\phi$ 36mm

[Sink] Acrylic artificial marble (seamlessly bonded with countertop)

[Bracket] Hairline stainless steel (SUS304) (W750, W900, W1200)/Steel white powder coating (W1500 only)

[Auxiliary Bracket] White powder coated steel (W1200, W1500)

[Accessories] Counter Bracket 460, Left and Right Pair (W750, W900, W1200)

Counter Bracket 500 2 pcs (W1500 only)

Auxiliary Counter Bracket 300 2 pcs (W1200 only)

Support bracket 400 2 pcs (W1500 only)

[Country of Origin] Japan

# Mortana Vanity

| Vanity

**The "Mortana Vanity" offers a trendy space.**

The ceramics countertop and the wall-mounted design gives it a clean appearance. And the size is just right. This product is recommended for those who loves a minimalist style of spaces.





Pattina W750mm



Pattina W900mm



Fuca W900mm



Fuca W900mm



Fuca W900mm



Pattina W1150mm



You can choose from a deep washbasin of "Pattina" Bowl and "Fuca" Bowl.



The joints of the tiles are cut at an angle of 45 degrees and butted together to create a beautiful edge.

**\* Countertops and sinks are sold separately**



White W450mm



Black W450mm



Gray W600mm



White W600mm

[Size] W750/900/1150 × D550 × H170mm  
 [Top panel] Porcelain tile  
 [Counter auxiliary bracket] White powder coated steel  
 [Accessories] Counter auxiliary bracket, fixing screws  
 [Country of origin] Japan, China

Mortana Mirror

Design tailored to the Montana Washstand.  
 The light Gray frame, narrowed down to 2.5mm, seamlessly blends into the wall surface, enhancing the presence of the washbasin. Easy to use individually and can be freely installed horizontally or vertically.

Faucet fittings



New Vega Mixer Faucet  
 TA05139N Black Matte  
 TA05129N White Matte



New Vega Mixer Faucet  
 TA01699N



W750



# Deliere

| Vanity

## Stainless-steel frame for sinks

This vanity goes perfectly with sanwacompany's original LISCIO and Caliza sinks. The simple design with a steel frame complements your favorite sink while creating a trendy space. The frame is also highly functional, with hooks for hanging towels and small items.



Deliere with LISCIO sink  
W600mm/W750mm/W900mm

[Size] W600/750/900 × D500 × H170mm  
[Bowl] Artificial marble (white: matte finish)  
[Frame] Steel, powder coating (matte finish)  
[Country of Origin] : Caliza: Japan,  
Liscio: Philippines, Frame: Japan

# Wood Custom Counter

**Transform your washroom and workspace into a natural wood counter with antibacterial and water-resistant specifications**

"Counters" that are versatile in various places in the home, such as washing spaces and small workspaces. With "Wood Custom Counters", they fit perfectly into the space and provide the warmth of natural wood. Depth and width can be customized in 1mm increments. They can be adapted to shallow counters for small spaces like toilets or wrap-around counters for kitchen walls.





# Custom Counter

A washbasin counter that looks like a design that embodies your own original washroom space

"Custom Counter" can be customized in widths with 1mm increments to fit any washroom space. The countertop, front panel, and side panels are processed with invisible "fastening" to achieve sharp edges similar to custom-made counters, giving the impression of a beautiful single board. The surface is finished with melamine, providing excellent water resistance and durability, with consideration for daily maintenance.



It is beautifully finished with a small invisible "fastening" process.

## Color

We have 13 colors, including mortar that is perfect for grayish and trendy spaces.

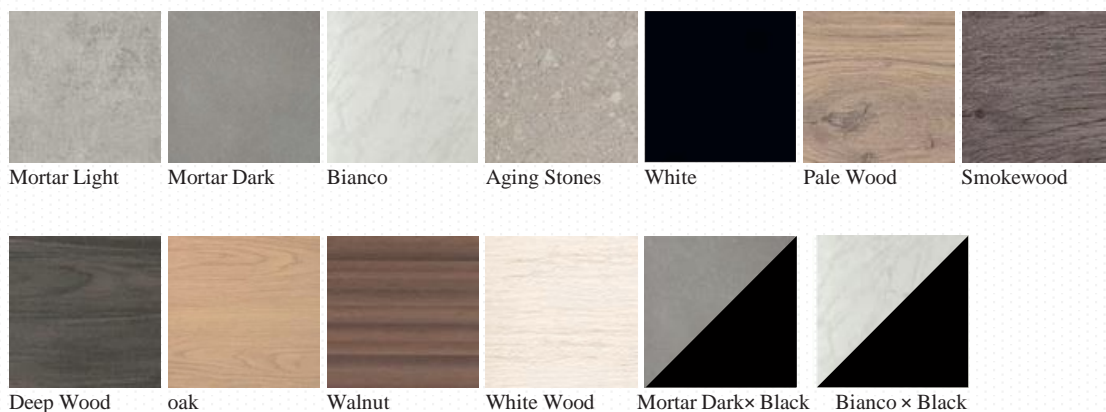

## Size

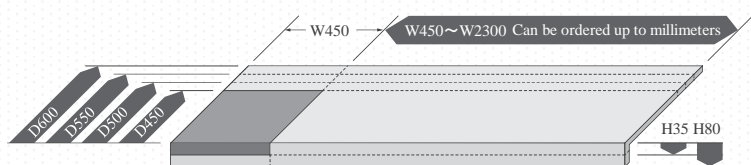

Can be ordered up to millimeters

《Order Range》

Width: 450~2300mm in 1mm increments

Depth: 450, 500, 550, 600mm

Visible height: 35 / 80 mm

\* The figure on the left is without side finishing.



### Recommended set with washbasin

There is also a product that comes with a popular washbasin.

\* When combining washbasins other than the set product, the top plate will be delivered without opening.



Fucca W450  
White



Elegance Square  
Matte Black

### Dedicated towel bar with a choice of colors and sizes

Sharp square towel bar to match the design of the custom counter. There are two colors, black and stainless steel hairline, and you can choose according to the space and counter color.

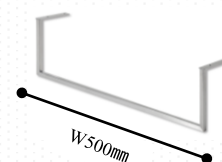
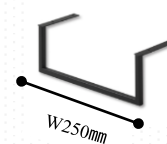



# WASHBOWL

---

●●● **sanwa**company

# Choice Fit Parts

Depending on the washbasin, the faucets and metal fittings that can be used differ. Please make sure you choose the right one.

## Wash-basin

There are many types such as standing type and wall mounting type. Find your ideal washbasin.



Tabletop type



Wall-mounted



## Drainage Plate

It is a receptacle for flowing water. There is one with overflow that can collect water and one without overflow that does not.

\* Please use an eye plate that matches the washbasin. There is also a hair catcher.

For overflow  
( Push-up formula )



For no overflow



## Water stop plugs

It is a hardware item that connects the water supply pipe and the faucet fittings (faucet). If you turn off this tap, water will not come out even if you turn on the faucet.

\* One shut-off tap is required for a single faucet and two for a mixed faucet. \* In the case of a wall-mounted faucet, a water shut-off tap may not be required.



## Faucet fittings

There is a mixed faucet that produces hot water and water, and a single faucet that produces only water. In addition to the general counter and bowl mounting type, there is also a wall-mounted type.

Counter Bowl  
Mounting



Shower  
Pull-out



Wall-  
mount  
ed



## Overflow

In order to prevent the accumulated water from overflowing, it will be drained from this hole when it reaches a certain amount. It is found in a bowl that has the ability to store water.

## Drainage traps

It is a pipe that connects under the drain valve, one for the wall and one for the floor, depending on the direction of the drainage. The B trap has a clean design, so it is recommended if you can see the trap, such as a washbasin with a wall.

B-trap (wall  
drainage)



P-Trap  
(Wall  
Drainage)



S-Trap  
(Floor  
Drainage)



# Industar Vanity

| Washbowl

## A washbasin that expresses Bauhaus philosophy

Industar Vanity, a unique design that prioritizes materiality, usability, and ease of installation. The material shaping this basin is the 'flat bar,' a durable, thick stainless steel favored by modern architectural master, Mies van der Rohe. This wash basin, designed to stimulate the sensibilities of creative individuals, showcases its beauty with every use. Available in two sizes with varying widths and two classic colors with a matte finish, the joints of the parts are inconspicuous, demonstrating meticulous attention to detail achieved through Japanese craftsmanship.





While made of thick stainless steel, the edges give a sharp impression compared to ceramics or artificial marble. The bottom is designed with a gentle gradient towards the drain, making it less prone to water accumulation



W400



W600



Integrating the bracket for wall mounting, this design eliminates any sense of discomfort from seams, achieving a beautiful form that combines simplicity and functionality

Material	Stainless steel (SUS304) powder coating
Size	W400 × D400 × H200 mm W600 × D400 × H200 mm
Overflow	x
Faucet mounting hole	ø36mm
Capacity	6L (W400) 9L (W600)
Accessories	Mounting screw
Maximum bowl depth	85 mm
Country of Origin:	Japan

Size	White	Black
W400	WA33001	WA33021
W600	WA33011	WA33031



## Fittings Option

### ■ Water faucet



Fixer Mixer  
White  
(TA01909N)



Fixer Mixer  
Matte Black  
(TA01919N)



New Vega  
Mixer White  
(TA05129N)



New Vega  
Mixer Black  
(TA05139N)



New Vega  
Mixer  
(TA01699N)



Rhythm  
Single faucet  
(TA01159)

### ■ Drainage traps



Flooring S-trap  
Chrome  
(MBAD004)



Flooring S-trap  
Matte Black  
(WA00381)



Wall-mount  
B-trap Chrome  
(WA00222)



Wall-mount  
B-trap  
(WA00371)



Wall-mount  
P-trap  
(WA00019)



Wall-mount  
P-trap  
(WA00391)

### ■ Pop-up waste drainage plate



Stainless  
(WA08011)



Matte White  
(WA34001)



Matte Black  
(WA34011)

### ■ Stop valve



Floor mount  
Stop valve  
(TA04099)



Wall-mount  
Stop valve  
(TA05509)

# C-Slu

| Washbowl

## Trendy colors and transparency washbowl to fit the room

Beautiful transparency is the next trend in living rooms and attracting attention at overseas exhibitions. C-Slu is a very sensitive sink that anticipates such trends. Its simple shape does not make noise even when installed in a small space, and gives the impression of spaciousness. These sinks also have sharp edges, which are difficult to achieve with glass or ceramics.







The secret of C-Slu's beauty comes from its hard-to-break clear material "C Material", which has never been seen in washbowls in Japan. "C Material", which uses polyester-based resin, is a material that allows us to bring you the beautiful transparency and trendy color that you would love to have for a washbowl.

**Color: Blue, Green, Black, Greige**



Blue



Green



Black



Greige

**Size**

Four color variations with a sense of transparency that shines in both morning light and night lighting.

☛ <Blue> and <Green> are trendy colors that accent a simple space, giving a special uplifting feeling to your daily personal hygiene.

☛ <Black> and <Greige> are calming colors that combine a sense of trend and a sense of grade.

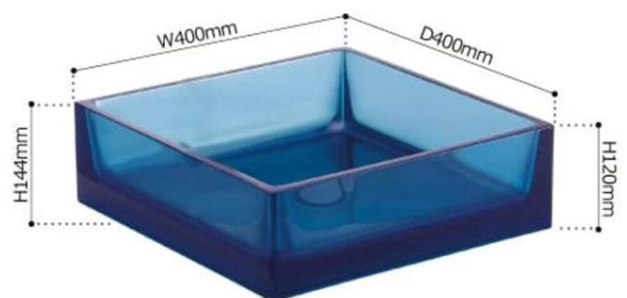

# Tehachi

| Washbowl

made in Japan

**Pursue the smallest size that can be washed by hand. Versatile in various places**

The biggest feature of "Tehachi" is its compact size, one of the smallest in the world. Just like the chouzubachi used to purify oneself at shrines and temples, the name refers to a small vessel used to wash one's hands before entering an important place.

It can be installed in small spaces in various places, from the entrances and corridors of houses to shops and public facilities. At home, it can be used not only for frequent hand-washing habits, but also for watering plants.





The bowl, counter and towel bar are integrated into a simple, linear design. The edges are raised by 5mm to prevent water from spilling onto the floor.



Even with the depth of only 12cm, it is large enough for handwash. Tehachi is characterized by its compactness, its weight 1.5kg is lighter than a typical wash bowl.



Silver WA14111



White WA14121



Black WA14131



Made from stainless steel, a durable material, Tehachi can be installed in the hallway of the house or outdoor

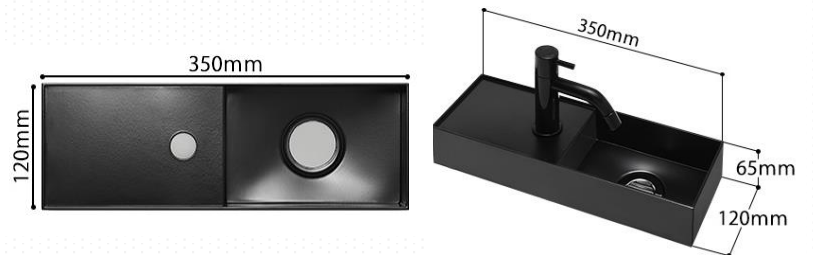

Material	Stainless-steel
Size	W350 x D120 x H65mm
Bowl depth	55 mm
Faucet mounting hole	Ø25 mm
Capacity	1.3L
Accessories	Bracket, towel rack, special perforated plate, bowl fixing screw, bracket fixing screw, towel rack fixing screw
Maximum bowl depth	115mm
Overflow	x
Country of Origin:	Japan
	Wall-mounted, stationary



# TEHACH

テハチ

■ Color □ Recommended installation height 820mm



Silver WA14111



White WA14121



Black WA14131

■ Conifer Single Faucet ※Single faucet only



□ White (TA05249)



□ Black (TA05239)



□ Chrome (TA05229)

■ Stop valve



□ Floor mount Stop valve (TA04099)



□ Euro Angle Wall mount Stop valve (TA01061)

■ Drainage Trap



□ S-Trap chrome (WA00231)



□ S-Trap Matte Black (WA00381)



□ P-Trap chrome (WA00019)



□ P-Trap Matte Black (WA000391)

□ Wall puff required

# Fucca

| Washbowl

**Deep wash bowl with stylish design,  
balancing trend design and daily needs**

The wash bowl "Fucca" is perfect for those people, who want to create a fashionable washroom space, but at the same time also think that practicality such as ease of use and ease of maintenance is still important.





The thin edges that can only be achieved with artificial marble, the color development that incorporates black and gray, and the matte texture are exactly the designs that meet recent trends.



White W450



Black W450



Gray W600



White W600

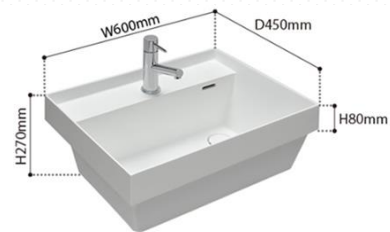

Material	Artificial marble
Size	W450 x D450 x H270 mm W600 x D450 x H270 mm
Storage size	D156 x H200mm
Faucet mounting hole	ø36mm
Capacity	15L (W400) 21L (W600)
Accessories	Perforated plate cover, Accessory plate, Wall mounting screw
Maximum bowl depth	22.0mm
Overflow	x
Country of Origin:	China
	Wall-mounted 



Option: Wood Plate  
Size: W130xD549xH14

# Rettangoro

| Washbowl

By using artificial marble, a square shape with an edge that is difficult with pottery and a matte finish with reduced luster are realized.

The deep bowl does not have to worry about splashing water and can store plenty of water.

The seamless design makes it difficult for dirt to collect in the gaps and is easy to clean.





White W600



Gray W750

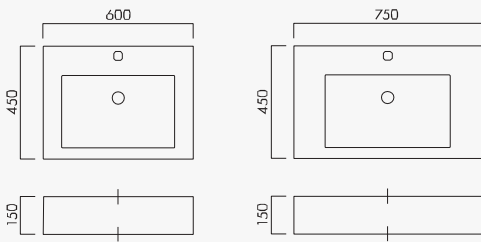

**Option**



Towel bar - Stainless steel W750



Towel bar – Black W750



Material	Artificial marble
Size	W600 x D450 x H150 mm W750 x D450 x H150 mm
Storage size	D156 x H200mm
Faucet mounting hole	ø36mm
Capacity	8L (W600) 9L (W750)
Accessories	Perforated plate cover (with hair catcher) Accessory plate, Mounting screw
Maximum bowl depth	110mm
Country of Origin:	Japan, Vietnam



# Cara

| Washbowl

made in Japan

“Cara” - a washbowl of minimum thickness and flat surfaces, enabled by proud Japanese metal processing in both plating and welding.

Great performance is exerted in wet areas due to the base stainless steel with a hybrid coating (organic/inorganic) with high hardness and durability and low pollutants.





The matte monotone texture adds modern taste to a space, and open shelf provides a neat storage for bath items.

Right-angled bend process was used during plating, to realize a sharp and simple design for ultimate minimalism for any space. Unlike ceramics, high-temperature firing is unnecessary, contributing to a CO2 emissions reduction effect.



**Color: White, Black, Gray**



**Size**

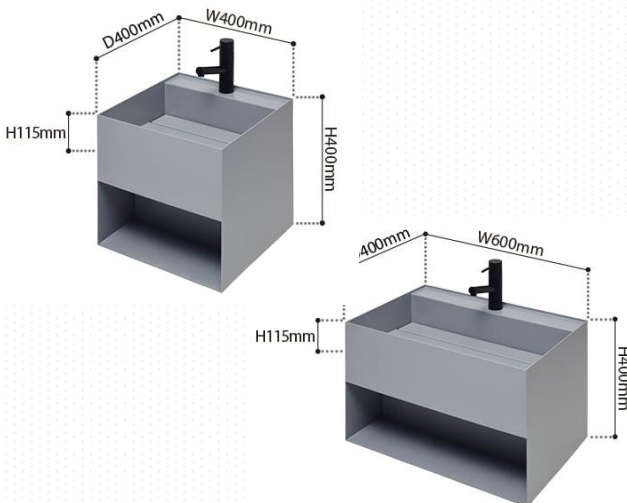

Size	White	Black	Gray
W400	WA28011	WA28021	WA28061
W600	WA28031	WA28041	WA28371

Material	Stainless-steel
Size	W400 x D400 x H400mm W600 x D400 x H400mm
Storage size	D156 x H200mm
Faucet mounting hole	ø36mm
Capacity	13L (W400) 19L (W600)
Accessories	Perforated plate cover, Accessory plate, Wall mounting screw
Maximum bowl depth	115mm
Overflow	x
Country of Origin:	Japan
Installation	Wall-mounted ※ Recommended installation height 820mm



■ Water faucet



□ Fixer Mixer  
White  
(TA01909N)



□ Fixer Mixer  
Matte Black  
(TA01919N)



□ New Vega  
Mixer Grey  
(TA05599)



□ New Vega  
Mixer White  
(TA05129N)



□ New Vega  
Mixer Black  
(TA05139N)



□ New Vega  
Mixer  
(TA01699N)



□ Rhythm  
Single faucet  
(TA01159)

■ Drainage traps



□ Flooring S-trap  
Chrome  
(MBAD004)



□ Flooring S-trap  
Matte Black  
(WA00381)



□ Wall-mount  
B-trap Chrome  
(WA00222)



□ Wall-mount  
B-trap  
(WA00371)



□ Wall-mount  
P-trap  
(WA00019)



□ Wall-mount  
P-trap  
(WA00391)

■ Stop valve



□ Floor mount  
Stop valve  
(TA04099)



□ Wall-mount  
Stop valve  
(TA05509)

# Asse

| Washbowl

made in Japan

## Mastering the Trend of Thin Edge Lines

The trend in recent years has been for washbasins to have thin edges. “Asse“ with stainless-steel material – has achieved a thin edge line that cannot be expressed in artificial marble or ceramic. By using a right-angled bend process taking advantage of Japanese metal processing techniques, it is only expressed as lines and surfaces without R-corners.





The user-friendly storage shelf adds an eye-catcher for the design. Drain hardware, including a perforated plate, is completely hidden to realize the beautiful design from every angle. Due to the metal material, the product is crack resistant. A hybrid inorganic/organic coating with high hardness and excellent stain and weather resistance is used for the coating.

**Color: White, Black,**



White W350



Black W350



White W500



Black W500

**Size**

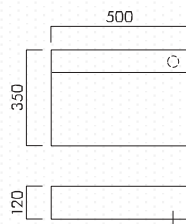
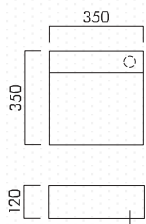

Size	White	Black
W350	WA28121	WA28131
W500	WA28101	WA28111

Material	Stainless-Steel (SUS304)
Size	W350 x D350 x H120 mm W500 x D350 x H120 mm
Overflow	x
Capacity	9L (W350) 13L (W500)
Accessories	Perforated plate, Perforated plate cover
Maximum bowl depth	82mm
Country of Origin:	Japan

# Orlonof

| Washbowl

## Edgy design and matte texture

The edgy, sharp design, chic color, and matte texture of the painted finish create a minimalist modern washroom space.



# Orlonof



A washbasin with an edgy design made from artificial marble. Make the edges stylish by making them slim to the limit.

Eliminating as much decoration as possible, the linear design that is extremely simple stands out with an edge unique to artificial marble that is impossible with pottery and glass.

The plate, on which small objects can be placed, can be moved from side to side and is easy to remove.

**Color: White, Black, Gray, Champagne**



White



Gray



Champagne



Black

## Size

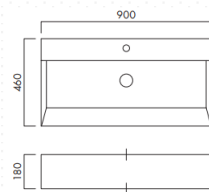
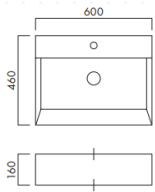

Material	Engineered stone
Size	W600 x D460 x H180mm W900 x D460 x H180mm
Faucet mounting hole	ø36mm
Capacity	13L (W600) 19L (W900)
Accessories	Perforated plate cover, Accessory plate, Wall mounting screw
Maximum bowl depth	110mm
Overflow	x
Country of Origin:	China
	Wall-mounted/ Table-top



# Caliza

| Washbowl

made in Japan

**A stylish morning wash could change your day.**

Made in Japan based on the design of Roberto Franco from Barcelona. Adopted artificial marble with heat resistance and acid resistance.



## Size



W600

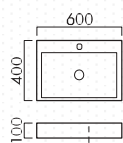

W750

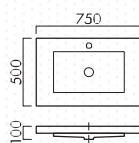

W900

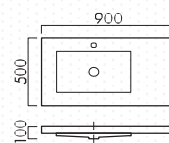

Material	Artificial marble (matte white)
Size	W600 × D400 × H100mm W750 × D500 × H100mm W900 × D500 × H100mm
Faucet mounting hole	ø36mm
Capacity	10L (W600), 12L (W750), 10.5L (W900)
Accessories	Wall fixing bracket hardware (steel/ chrome plated finish), mounting parts
Maximum bowl depth	75mm
Overflow	x
Country of Origin:	Japan



# SUSCaliza

| Washbowl

made in Japan

**Square stainless-steel bowl that stands out for its sharpness**

Extreme form of simple design - SUSCaliza is the product made to match for any kind of space design.

No decoration, no nothing. Just make it simple.



Washroom

## Size

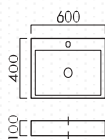

SUSCaliza 600

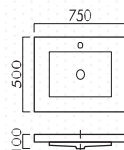

SUSCaliza 750

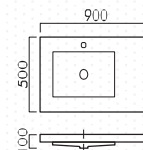

SUSCaliza 900



SUSCaliza, unlike traditional ceramic wash basins, is crafted from stainless steel, offering a distinct metallic aesthetic and simple form. Its durable material ensures lasting cleanliness in your washroom space.

Size	Type	Code
W600	Countertop	WA14251
	Wall-mounted	WA14221
W750	Countertop	WA14241
	Wall-mounted	WA14211
W900	Countertop	WA14231
	Wall-mounted	WA14201

[Size] W600 x D400 x H100mm W750/W900 x D500 x H100mm )  
 [Material] Stainless steel (SUS304 hairline finish)  
 [Faucet mounting hole diameter] ø36mm  
 [Overflow] None  
 [Capacity] 10L (W600), 12L (W750), 10.5L (W900)

[Appearance height] 100mm (W600), 50mm (W750, W900)  
 [Maximum bowl depth] 75mm  
 [Accessories] Wall fixing stainless steel bracket hardware, mounting parts  
 \*Wall fixed version only  
 [Country of origin] Japan

# Borde

| Washbowl

made in Japan

A pure white washbasin with shading in a shape covered with functional beauty.

To accentuate the beauty of the shade, pure white artificial marble is used and the eyelet is covered with the same material. A counter space is provided next to the washbasin for convenience.



Size: W750 x D500 x H350 mm  
Made of artificial marble (white: matted)  
No overflow  
Faucet mounting hole:  $\varnothing$ 68mm  
Capacity: 25L  
Maximum bowl depth: 115mm\*(4.53 inch)  
Accessories: Anchor bolt for fixing, special eyelet, special faucet, drain trap  
Country of Origin: Japan  
Not compatible with any faucet other than the dedicated faucet.  
Faucet required separately  
Not intended for use in cold climates.



# Thin Edge

| Washbowl

Curves and matte texture give a modern and light impression

Thin Edge" adds a modern lightness to artificial marble with its thin rounded edges and matte texture.



Washroom

## Size

The 380 mm circle shape is easy to use for hand washing, and the 580 mm oval shape is large enough to wash your face.



White 380

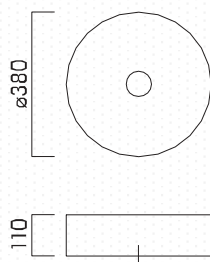

Black 580

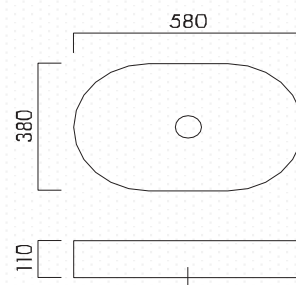

# Spinning

| Washbowl

made in Japan

**Formative beauty of stainless-steel material created by craftsmanship**

The stylish appearance of the "Spinning" is the result of a technique called "spinning" that has been handed down from generation to generation.



Washroom

The product was awarded the German Design Award for its artistic beauty created by a limited number of Japanese craftsmen.

Specification  
Outer size:  $\phi 350 \times$  Height 135mm  
Bowl Depth: 115mm  
Bowl Capacity: 5.5L  
Materials: Stainless steel hairline finish (SUS304)  
Country of Origin: Japan

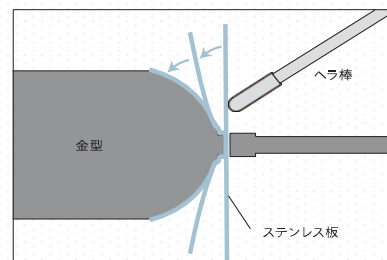

SPINNING  
WA14301

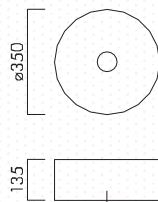

Hemisphere made by a metal lathe is almost perfect circle, and circular slit and simple form express the universal beauty.



# Angolo

| Washbowl

made in Japan

ANGOLO is a stainless-steel wash-hand basin designed for bathrooms with tight space constraints, e.g. for shops and bachelor apartments.

Its minimal size realized by a stainless-steel top panel with a round sink allows for effective use of space even in a narrow wash-hand space.

The 3 mm stainless steel top panel is strong enough to withstand hard use and is easy to clean and gives the sink both durability and a pleasant appearance.





### Variation

The lineup includes two types: "Angolo Flat," which is installed on a flat wall, and "Angolo," which fits snugly into a toilet corner



#### Specification

Angolo Size: W350 x D350 x H112 mm  
 Angolo Flat Size: W280 x D350 x H112 mm  
 Materials: Stainless steel blast finish (SUS304)  
 Bowl Depth: 105 mm  
 Bowl capacity: 3.0L  
 Water tap hole size: φ25mm  
 Overflow: X  
 Country of Origin: Japan



Angolo Flat



Angolo

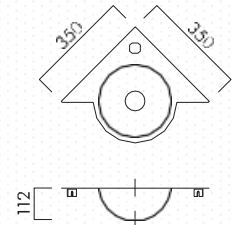
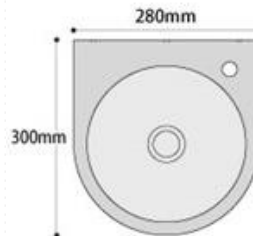

Set Name	Angolo	Angolo Flat (Right Faucet)	Angolo Flat (Left Faucet)
S Set	ANG007	ANGF013	ANGF014
P Set	ANG008	ANGF015	ANGF016
B Set	ANG009	ANGF017	ANGF018

※ Accessories:

Faucet, Drain plate, Drain trap (S trap, P trap, bottle trap), Mounting screws

# Shigaraki En

| Washbowl

made in Japan

## Fusion of Traditional Shigaraki Ware Technology and Design

Shigaraki ware, which has been handed down from the Middle Ages to the present and is counted as one of the "Six Ancient Kilns of Japan", is characterized by its rustic taste that comes from rough clay. "Shigaraki En" brings out the pottery techniques with sanwacompany's simple design. The two monotone colors and the perfect circular form give a clean impression that is in harmony with the Japanese spirit.



Black



White

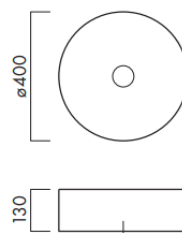

Specification  
Countertop washbowl  
Size:  $\phi 400 \times H130$ mm  
Material: Ceramic (Shigaraki ware)  
Without overflow  
Capacity: 5L  
Maximum bowl depth: 100mm  
Country of Origin: Japan

# Shigaraki

| Washbowl

made in Japan

**Shigaraki ware made with the utmost care**

**A space rich in flavor**

Shigaraki" is a modern washbasin made from Shigaraki ware, which was closely associated with daily life in the Edo period. "Shigaraki" is popular for its high quality backed by tradition, which is created from high quality clay and fired with great care.



Shigaraki Roll



Shigaraki



Shigaraki Mano

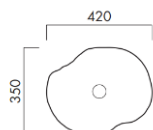

Specification  
Countertop washbowl  
Ceramic (Shigaraki ware)  
Without overflow  
Country of Origin: Japan



# Shigaraki Concrete

| Washbowl

made in Japan

Let's bring a Japanese vibe to your house with Shigaraki Concrete, Shigaraki-yaki, one of the six oldest kilns in Japan, originated in Shigaraki, Shiga Prefecture, in the Kamakura period (1192-1333). Shigaraki Concrete was created with a modern design that blends well with modern architectural spaces, while taking advantage of the simple, unglazed texture of Shigaraki ware. While retaining the quality of traditional craftsmanship, this product can be used as a beautiful everyday item for many years to come.



Shigaraki Concrete 270  
 $\phi 270 \times H110\text{mm}$ ,  
 Capacity: 3.5L  
 Made from Pottery  
 Country of Origin: Japan



Shigaraki Concrete 350  
 $\phi 350 \times H110\text{mm}$ ,  
 Capacity: 4.5L  
 Made from Pottery  
 Country of Origin: Japan



Shigaraki Concrete Square  
 $W360 \times D280 \times H110\text{mm}$ ,  
 Capacity: 4L  
 Pottery (Shigaraki ware)  
 Country of Origin: Japan



Mortar  
 WA06439



Sumi Mortar  
 WA06499



Mortar  
 WA06419

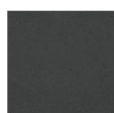

Sumi Mortar  
 WA06429



Indigo Blue  
 WA06519



Sumi Mortar  
 WA06529



# Pratico

| Washbowl

made in Japan

## Impact and practicality realized in a space-saving design

At 17 cm deep, this minimalistic design wall-mounted hand wash basin is extremely slim and space-saving bringing an edgy feeling. Using stainless steel as the base material, the minimalist design with thin edges, which makes full use of Japanese metalworking technology, makes a fresh impact on the user.





The high-back design with high hardness and durability coating also provides practicality to guard against water splashes. Durable stainless steel is used as the base steel material to achieve the latest interior trend slim edge.

## Size

Material	Stainless Steel
Size	W450 x D170 x H400mm
Faucet mounting hole	ø25mm
Capacity	3L
Accessories	Perforated plate cover, Accessory plate, Wall mounting screw
Maximum bowl depth	52.5mm
Country of Origin:	Japan
	Wall-mounted/ Table-top

The sharp form and achromatic black & white color can fit any space regardless of taste.



Black



White

Color	Pratico White	Pratico Black
Right Faucet	WA28241	WA28261
Left Faucet	WA28251	WA28271

# Lepto

**Slim hand wash basin with 170mm depth  
New gray color now available!**

Fit neatly into limited spaces. The compact hand wash basin 'Lepto', embodying the aesthetic consciousness of the Japanese, now comes in a new color: gray. Gray harmonizes easily with any space and serves as a moderate accent, complementing wood textures and gold accessories. While existing white and black options feature a glossy finish, the gray variant boasts a matte finish that reduces shine, aligning its texture with current trends.



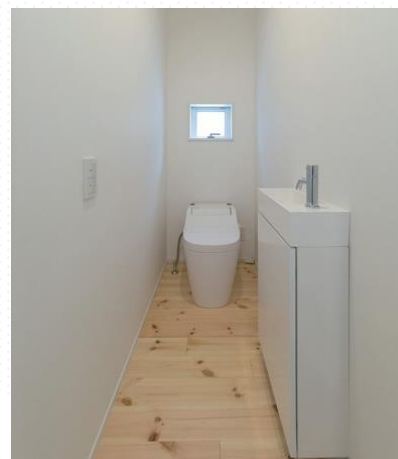

Standing Type:  
W450 × D170 × H800mm

Wall mounted type:  
W450 × D6.69 × H550mm



Standing Type  
White

Standing Type  
Black

Standing Type  
gray **NEW**

Wall mounted type  
white

Wall mounted type  
black

Wall mounted type  
gray

Color	Code
White	LEP041P
	LEP041S
Black	LEP042P
	LEP042S
Black (faucet black)	LEP046P
	LEP046S
Gray	LEP050P
	LEP050S
Gray (faucet black)	LEP054P
	LEP054S

Color	Code
White	LEP043P
Black	LEP044P
Black (faucet black)	LEP048P
Gray	LEP052P
Gray (faucet black)	LEP056P



Black faucet is also available

Sink and cabinet are the same specifications for left and right side.  
“P” in the Model code is a P-trap and “S” is an S-trap .  
Wall-mounted type is available with P-trap only.  
Water tap is not included.  
Tolerance -1,+2 mm

[Bowl] artificial marble No overflow /  
Capacity: Faucet mounting hole: mm / Bowl depth max: mm  
[Base cabinet] Storage: Hinged door / Door: White / Black Mirror decorative plywood finish / Gray matte finish / Push-open finish  
[Skirting board] stainless steel ( ) hairline finish (standing type only)  
[Accessories] Water faucet, special eye plate, drainage trap, mounting screw, anchor bolt set, 1 drill bit for hole processing  
[Country of origin] Japan, Vietnam

W450 × D170 × H100mm  
Artificial marble  
No overflow  
Faucet mounting hole: ø25mm  
Capacity: 3L  
Maximum bowl depth: 85mm  
Attachment : Drainage tray  
Country of origin: Japan, Vietnam

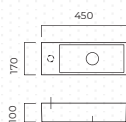

White



Black



**NEW** Gray

# Lepto Counter

**Slim and modern hand washing counter with a new gray color!**

Featuring space-saving design and modern aesthetics, the 'Rep Countertop' has won numerous design awards. With the addition of a new matte gray color, it now comes in three color options, expanding the possibilities for space decoration. With a slim design depth of 170mm, it comes in two installation styles: freestanding and wall-mounted. It can be used not only in toilet and washroom spaces but also as a sub-sink in kitchens and living areas. The countertop can be cut on-site to fit the available space.



Stand-alone  
white



壁付ブラック (水栓ブラック)



Stand-alone **NEW**  
grey

# LEPTO INWALL

| Washbowl

Well organized limited space – this is one of Japanese sense of beauty. The concept of our product, slim wash basin Lepto, is coming from this Japanese sense of beauty.



LEPTO INWALL is our new product, as you can guess, in-wall type Lepto. Place Japanese smallest slim wash basin into your wall. It needs less space but creates simple and clean space. Cabinet hides drain-pipe, and also stock some toilet paper.

Dimensions

W460 × D250 × H800mm

Materials: Artificial marble



# Tubo

| Accessories

made in Japan

"Tubo" is a series of bath accessories that are made up of thin and beautiful round pipes that softly color washrooms and sanitary spaces. The design, which consists of thin cylinders, creates a delicate and light impression. Another nice point is that the price is affordable even though it is made in Japan. With a simple design that you will never get tired of and color variations, you can coordinate it with various spaces.





# Tube



**Tube Paper Holder**  
W160 × H40 × D80mm



**Tube Towel Ring**  
W210 × H40 × D60mm



**Tube Towel Bar**  
W470 × H20 × D60mm



## 1. A simple form composed only of cylinders

Minimalistic and simple form with reduced design elements, "Tube" looks neater by realizing a fit that does not show the fixing screw.



## 2. Color Variations

In addition to the pure white, black, and silver colors that give a stylish impression, bronze, blast gray, and mortana gray have been added with a wide range of coordination in mind.



## 3. Coordinate it with various spaces

The design, which consists of thin cylinders, creates a delicate and light impression. Another excellent point is that the price is affordable even though it is made in Japan.

# Industar

| Accessories

made in Japan

## A vintage stainless-steel accessories reproducing Bauhaus functionalism

The base material is stainless steel, which is highly durable for commercial use. The shape was created from a single sheet of stainless steel by sheet metal working alone, aiming for a universal functional beauty with minimal decoration. Industar can be used not only for washrooms but also for interior storage.



# Industar



**Single Shelf ME09109**

W350 × H62 × D120mm



**Double Shelf ME09119**

W350 × H190 × D120mm



**Towel Bar ME09129**

W350 × H54 × D57mm



**Paper Holder ME09139**

W145 × H175 × D125mm



With functionality first and foremost in mind, the beauty of the material, stainless steel, has been maximized.



Stainless steel is water resistant and highly durable, INDUSTAR is perfect for the washroom area, as well as for small designed storage in the living room and entrance.



INDUSTAR can be used in various ways depending on the combination. Simple design that easily blends in with any interior design space.

# Sqrib NEW

| Accessories

**'Sqrib,' crafted by bending aluminum bars to create gentle, rounded forms that add a touch of warmth within simplicity.**

A single piece of angular bar bent into shape, creating the 'Scribe' series. Its simple design adds a touch of gentleness with rounded forms. With 5 variations of items that can be coordinated around the washroom or bathroom, trays and paper holders can also be combined. Available in 3 colors with a matte finish for a unified look. Included are same-color concealing rubber plugs to hide screws when inserted into mounting holes.

Washroom

## Color



White



Black



Gray



## Variation



Robe Hook



Towel bar



Towel Ring



(L)



(R)

Paper Holder



Single



Double

Tray

Sqrib	White	Black	Gray
Robe Hook	BA21016	BA21023	BA21030
Towel Bar	BA21012	BA21019	BA21026
Towel Ring	BA21013	BA21020	BA21027
Paper Holder R	BA21014	BA210 21	BA21028
Paper Holder L	BA21015	BA21022	BA21029
Tray (Single)	BA21010	BA21017	BA21024
Tray (Double)	BA21011	BA21018	BA21025



By combining the paper holder (L · R) with the double tray, you can create a double paper holder with a tray. Paper holder can be installed not only horizontally but also in two tiers vertically.

[Size] Robe hook: W10 × H82.5 × D37.5mm, Towel bar: W450 × H55 × D55mm, Towel ring: W195 × H70 × D60mm, Paper holder: W140 × H70 × D80mm, Tray (single): W130 × H25 × D100mm, Tray (double): W280 × H25 × D100mm  
 [Material] Aluminum  
 [Finish] Baked paint  
 [Accessories] Concealing rubber (same color as the body)  
 [Country of Origin] Japan/China  
 \*Can be used in water areas (kitchen, washroom, toilet), including bathrooms, but avoid installation in places where water constantly splashes.

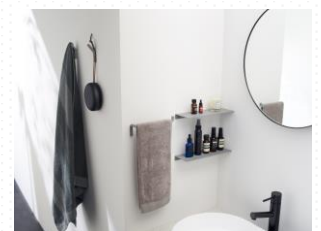

# Color Faucets

Create a washroom space reminiscent of overseas style with a matte paint finish.

For a matte finish with no gloss, our original color faucets are recommended to be paired with washbasins that share a similar matte texture. Matching the colors of the faucet and washbasin creates a sense of unity in the overall design of the bathroom, while contrasting colors enhance the aesthetics of the washbasin's design.



Matte White



Matte Black

## Fixer Mixing Faucet

TA01909N White Matte  
TA01919N Bloc Mat

Mounting diameter ø35~38mm  
Foamy water  
Shared in cold regions  
Mounting hole spacer included (Ø24~25mm compatible without spacer)  
Country of origin: Japan



White Mat



Matte Black

## New Vega Mixer Faucet

TA05129N White Matte  
TA05139N Black Mat

Mounting diameter ø35~38mm  
Foamy water  
Mounting hole spacer included (Ø24~25mm compatible without spacer)  
Country of origin: Japan



White Mat



Matte Black

## New Vega Tall Mixer Faucet

TA05149N White Matte  
TA05159N Bloc Mat

Pick-up diameter ø35~38mm, foam spitting  
Country of origin: Japan

# Tapware

Water stoppers and drainage fittings

## Drainage fittings

In drainage fixtures, there are drainage gratings that serve as the inlet for water flow, and drainage traps installed below the drainage valve, with specifications varying depending on the type and purpose of the wash basin.

### Drainage traps



B Trap [Wall Drainage]

The trap is shaped like a bottle, featuring a neat design. It is recommended for situations where the trap is visible, such as wall-mounted wash basins



P Trap [wall drainage]

This is a structure where water accumulates and acts as a plug by bending the drainage pipe into a P-shape. It is designed to horizontally exit the wall.



S Trap [Floor Drainage]

This is a trap designed specifically for floor drainage systems with an S-shaped bend in the drainage pipe.

### Drainage Plate

Two types are available: one with an overflow for water retention and one without an overflow. Each type comes with or without a hair catcher to prevent the entry of hair and other debris.



For without overflow



Hair Catcher



Stainless (WA08011)



Matte White (WA34001)



Matte Black (WA34011)

■ Pop-up waste drainage plate for overflow

### Black Drain Trap

The matte black original drainage trap is now available. It's recommended for trendy monochrome coordination with black faucet fixtures and Gray wash basins.

B Trap [Wall Drainage]



S Trap [Floor Drainage]



P-trap [wall drainage]



# Cosme-Cabi

| Storage

made in Japan

Registered Design No. 1424213

## Storage Cabinet Inspired by Women's Insights

Addressing the concerns of women struggling with organizing small cosmetics and accessories, Cosme-cabi has been created. Available in a sleek silver aluminum and a matte black finish, it offers both a sharp impression. With two types of doors, one with a mirror and the other semi-transparent, it's designed to be slim enough to fit in narrow spaces without being obtrusive, making it suitable for various uses including bathrooms and entryways.



Cosme-cabi 45-180

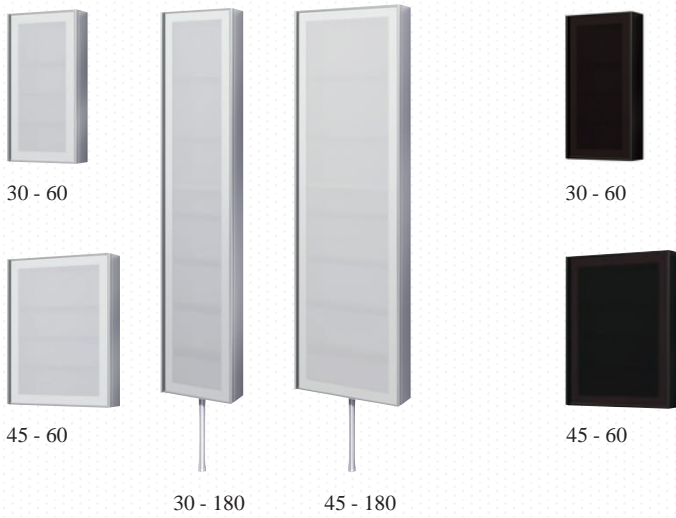

### Cosme-cabi Mirror

Size	Code
30 - 60	FU09051
45 - 60	FU09061
30 - 180	FU09071
45 - 180	FU09081

### Cosme-cabi Mirror Black

Size	Code
30 - 60	FU09161
45 - 60	FU09171

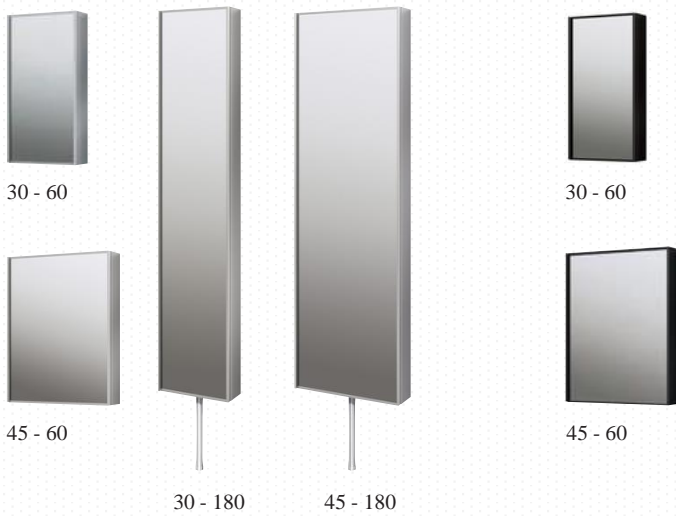

### Cosme-cabi Mirror

Size	Code
30 - 60	FU09091
45 - 60	FU09101
30 - 180	FU09111
45 - 180	FU09121

### Cosme-cabi Mirror Black

Size	Code
30 - 60	FU09181
45 - 60	FU09191



Matches monotone codes.

Cosmecabi  
Black 45-60



Even if it is thin, it can store plenty of things.

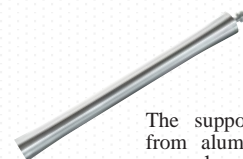

The support leg is machined from aluminum. The elegance was enhanced by subtly thinning the center.

#### [Size]

- (30 - 60) W300×H600×D126mm (Inner dimensions: W270×H570×D77mm)
- (45 - 60) W450×H600×D126mm (Inner dimensions: W420×H570×D77mm)
- (30 - 180) W300×H1500 + Leg L300×D126mm (Inner dimensions: W270×H1470×D77mm)
- (45 - 180) W450×H1500+ Leg L300×D126mm (Inner dimensions: W420×H1470×D77mm)

[Body, door frame] Black: Anodized aluminum (matte black) Aluminum: Anodized (matte silver) [Door material] Black: Translucent door (polycarbonate), mirror door (t=3mm anti-rust treatment) Aluminum: Translucent door (acrylic), mirror door (t=3mm anti-rust treatment)

Shelf: Tempered glass (thickness 4mm)

Legs: Machined aluminum (mirror finish) [Total load capacity] (body) Height 600mm: 10kg, Height 1800mm: 20kg (Shelf) 1kg [Country of origin] Japan



# Medicine Cabinet

| Storage

made in Japan

**Floaty mirrors gracefully glide from side to side.**

Slide-Type Mirror Cabinet, With its sliding design, you can achieve open storage that showcases your stylish cosmetics and decorative bottles. Embrace the beauty of 'display storage' and elevate your interior décor.



Sleek design with concealed rails for a clean look. Ample storage capacity makes it perfect for any space, not just limited to the washroom.

## Medicine Cabinet 600

FU09131

W600 × D126 × H464mm

(Inner dimensions: W570 × D77 × H383mm)

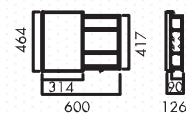

## Medicine Cabinet 750

FU09141

W750 × D126 × H464mm

(Inner dimensions :  
W720 × D77 × H383mm)

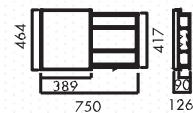

## Medicine Cabinet 900

FU09151

W900 × D126 × H464mm

(Inner dimensions :  
W420 × D77 × H383mm × 2 aperture)

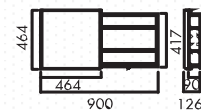

\* The W900 size has a middle partition.



Medicine Cabinet 600



Medicine Cabinet 750



Medicine Cabinet 900

[Main Body] Aluminum material with an anodized matte silver finish.  
[Cabinet] Doors: 4mm thick rust-resistant mirrored surface.  
Shelves: Tempered glass (W600, W900: 4mm, W750: 6mm).  
[Total Load Capacity] 10kg (1kg per shelf).  
[Country of Origin] Japan.

# Smith

| Mirror Box

**Design is minimal, storage is ample in a slim mirror box.**

Smith Slim Mirror Box is perfect for those who want to keep their washroom space neat while needing sufficient storage. With its shallow depth, it doesn't create a sense of clutter in the space, yet it ensures ample storage capacity. Since there is no frame supporting the mirror part, it presents a noiseless design where only the mirror appears to float in the space when viewed from the front.

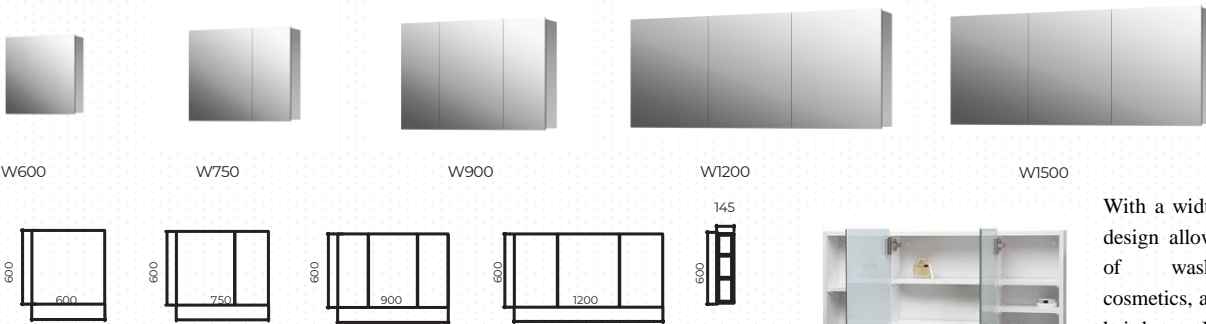

[ Size ] W600, 750, 900, 1200×D145×H600mm  
 [ Body ] Melamine double-sided makeup particle board  
 [ Cabinet ] Storage: Hinged door / Door: Mirror (thickness 3 mm) + glass (thickness 4 mm)  
 [ Total load capacity ] 30 kg [ Country of origin ] Japan



With a width of 145mm, this slim design allows for efficient storage of washroom accessories, cosmetics, and even appliances like hairdryers. Inside, there are options with built-in power outlets and types with fog-resistant mirrors (anti-fog film) available

# Mirror LINEUP



## Ar Mirror

### Color



Gray

Bronze



### Size



W300

W400

W500

W600

[ Size ] W300, 400, 500, 600× D100×H700mm  
 [ Frame ] Steel / Baking Paint Matte Blast Finish  
 [ Mirror ] 5mm thick (moisture-proof type)  
 [ Load capacity ] 2kg  
 [ Accessories ] mounting screws, wall-mounted spacers  
 [ Country of origin ] Japan



## Fine Mirror

### Color



White

Black

### Size



W450

W600



## Mirror Shelf

### Color



White

Black

### Size



W500×H758

W600×H508

W750×H508

A simple design that combines a minimalist form with the beauty of minimalism, featuring a mirror and a tray for placing toiletries and other items.

# Mirror LINEUP



## Mortana Mirror

GOOD DESIGN  
AWARD 2021

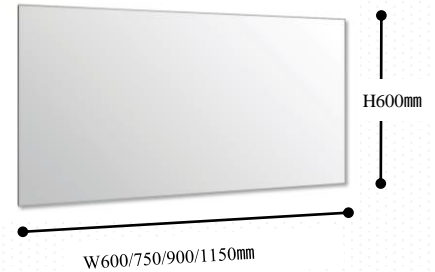

A simple design that fits perfectly with the "Mortana washbasin". With a light gray frame that is extremely thin at 2.5 mm, it blends into the wall and further enhances the presence of the washbasin.

■ Size



□ W600



□ W750



□ W900



□ W1150



## Karimoku Mirror

●●● sanwacompany  
×  
karimoku

■ Size



□ W800



□ W1200



## Practical Mirror

[Size] W300, 450×D30×H600mm,  
W450×D30×H450  
[Frame] Aluminum Baking Paint  
[Mirror] 5mm thick (moisture-proof type)  
[Accessories] Mounting screws,  
spacer hardware  
[Country of origin] Japan

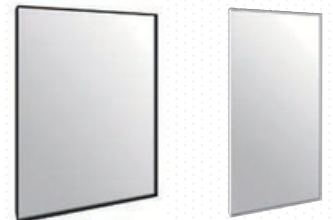
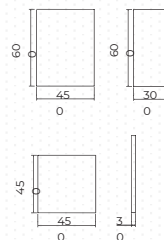

Black W450×H600 White W300×H600



## Bath – Door - Storage

●●● **sanwa**company

# Novum

| System-Bath

made in Japan

A system bath "Novum" that has both stylish design and functionality.

Since it is a place that is used every day, it has been renewed in consideration of its beauty and ease of use, its resistance to dirt, and its ease of maintenance.

We also offer a full range of options for upgrading the bathroom to provide a comfortable space as you wish.





# Novum

**A system bath "Novum" that has both stylish design and functionality.**

Since it is a place that is used every day, it has been renewed in consideration of its beauty and ease of use, its resistance to dirt, and its ease of maintenance.

We also offer a full range of options for upgrading the bathroom to provide a comfortable space as you wish.





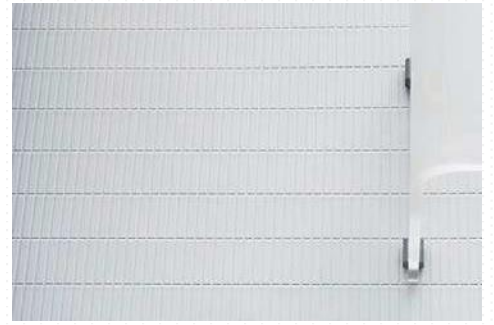

### Clean Floor

The edge of the floor is raised, making it stain-resistant and waterproof. In addition, the floor surface is uneven to prevent slipping and to make it easy to dry.



Stylish without feeling like "storage"  
Stainless steel mirror shelf



※イメージです

### Bubble bath at home!

Ultra fine bubbles, which are too small to be seen by the naked eye, are generated when the water is heated and when the water is reheated. The effect is expected to have a warming effect that keeps the body warm to the core, a cleaning effect that makes it easier to remove sebum and dirt, and a beautifying effect that increases the moisture content of the skin.



**Wall Panels** Standard Specifications

All 15 patterns of wall panels create the ideal space. For the wall panels, which greatly affect the impression of the bathroom, you can choose from a total of 15 patterns, 5 patterns that incorporate trendy mortar tones and grayish colors to make the entire surface the same color, and 10 bi-color accent wall patterns. Coordinate with the bathtub and floor to achieve the space of your choice.

**All the same color walls**

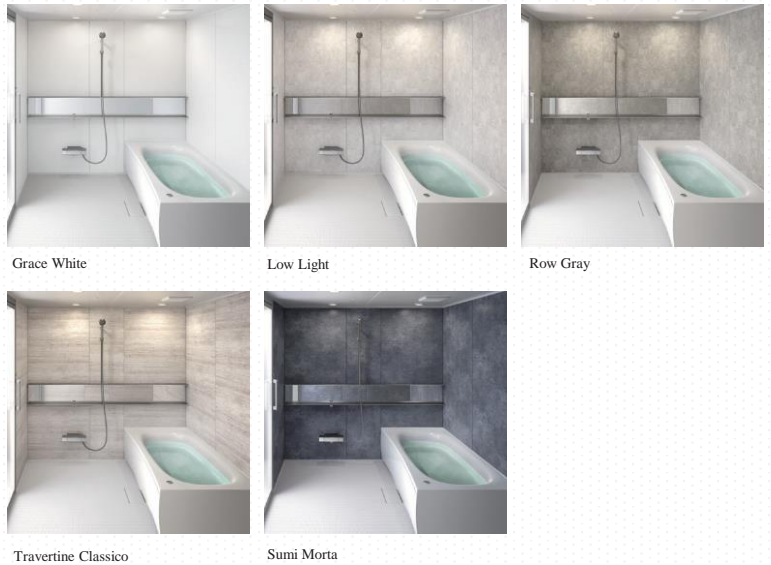

**Accent wall**

There are different color patterns for the front and surrounding walls to combine and achieve a good match. Pairing different color patterns of walling will give an impression to the bathroom.

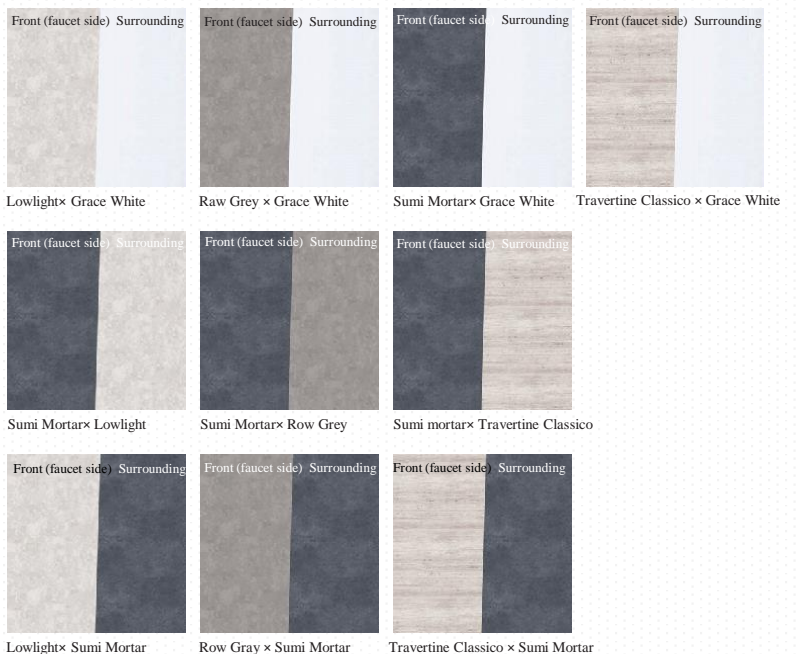

## Bathtub shape

Standard Specification

### Pursuing a relaxing bathtub shape to match the space

For detached houses, we offer an arch bathtub, which is shaped to allow the user to stretch his or her legs in hot water up to the shoulders, and for condominium remodeling, we offer a simple, flat, straight bathtub.



Arch bathtub (for detached houses)



Straight bathtub (for condominium renovation)

The photo shows the shape of the 1116 and 1216 sizes (without armrests). 1317 and 1418 sizes have armrests.

## Bathtub heat insulation

Option

### Warmth that completely envelops the bathroom

The bathtub is wrapped with heat-insulating material, and the bath lid is also insulated to provide a high heat-retaining effect. With a heat-retaining bathtub, you will be greeted with a warm bath even if you return home late.



Comparison of heat retention performance by thermography

Insulated bathtub

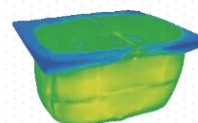

The outside of the bathtub is low temperature (blue) because it is almost impossible for heat to escape.

Uninsulated bathtub

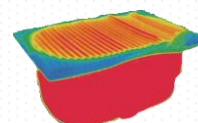

Heat escapes rapidly, and most of the outside of the tub is red.

[Measurement conditions] Taken with Thermopure 10 minutes after closing the bath lid at a water temperature of approximately 43°C and full of water.

In the case of bathtub heat insulation, the bathtub cover is an "insulated lid".

## CLEAN BATHTUB

Option

### Beautiful luster and smooth touch make it hard to get dirty and keep clean for a long time.

The firm thickness and smooth surface give it a high-quality feeling and texture when you sit on or rest your body on it. In addition, the material is kneaded with stain-resistant ingredients to prevent stains and scratches, making it easy to clean.

Water-repellent and oil-repellent ingredients are blended into the material, making it resistant to water stains and sebum stains



### ●Comparison of water stain removal performance

(Compared with a durable sample equivalent to 1 month of water stain adhesion and 10 years equivalent to the surface of the bathtub)

FRPbathtub

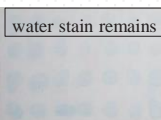

Clean bathtub



After dripping the water stain component, dry and rub lightly with a force of 500g weight.

After dripping the water stain component, dry and rub lightly with a force of 500g weight.

\* The water stain in the photo was artificially developed based on the actual ingredients (according to company P) and is colored for easy identification. Experiments were conducted on the average concentration of the ingredients nationwide.

### ●Comparison of antifouling performance of sebum oil (oleic acid adhesion experiment)

FRPbathtub



Clean bathtub



※Oleic acid: the main component of sebum. It is also included in cosmetics. \* Oleic acid is colored for easy identification.

# Shower Booth 700

| Shower Booth

made in Japan

## Elegant Shower Time Surrounded by High-Quality Design

Shower booths are ideal for today's busy lifestyles, allowing you to work up a sweat more easily than taking a bath. Enjoy a moment of healing in a premium space with both design and functionality in a space-saving design.





In addition to the existing two colors of white and black, the wall panels now come in the same four colors as sanwacompany's "NOVUM" system bath.

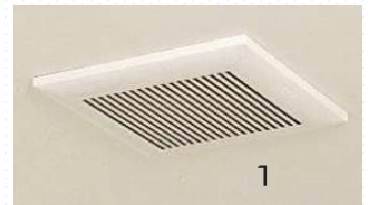
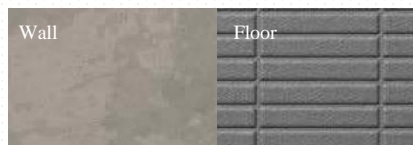
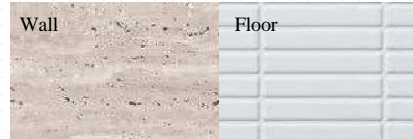

The floor is designed to be comfortable for wet feet, and is coordinated with the wall panels in the same color. In addition to the environmentally friendly wall panels, stylish vertical mirrors, and other high-grade components, options are available to further enhance the luxurious feel of the shower stall. Three ceiling heights and two depths are available, and the 0712 size can be arranged to suit your needs, including the option of a single swinging door.

[Basic Components] Ceiling panel: Decorative steel plate (Grace White)  
 Wall panel: Decorative steel sheet (Grace White, Black Random Line, Low Light, Travertine Classico, Sumi Mortar, Low Gray) Low Gray)  
 Floor panel (waterproof pan): FRP (medium white, medium gray)  
 [Drainer cover and drainer trap: Resin drainer eyelet / drainer trap with hair catcher  
 [Country of origin] Main unit: Japan

# Traspa

| Shower booth

**The space looks spacious and clean.**

Minimal design wrapped in glassThe shower booth "Traspa" is designed to be as simple as possible, consisting of only the minimum number of elements. It is made of tempered glass, which is highly durable and maintains a sense of openness in the space without being overly conspicuous.





**Composed of a minimum number of parts**  
 “Traspa” is composed of the minimum number of parts, with no waste down to the smallest detail. The corner joints have been made as thin as possible to create a beautiful shower time as if it were made only of glass.



White Floor

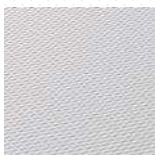

Black Floor

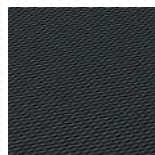

# Balnea

| Half Unit Bath

**A half-unit bath that realizes a discerning space is born**  
You want a stylish bathtub in your bathroom. However, the waterproofness of the unit bath and the ease of maintenance are also hard to get rid of. The "Balnea" has been long awaited by such people and has finally been born.



This is a so-called "half unit" that combines the advantages of a unit bath with those of conventional construction. The bathtub is designed to be easy to use, with the piping for the reheating system, which would normally be exposed between the walls, is placed under the floor. The structure prevents the drainage from the bathtub from flowing into the washing area. You can choose your favorite bathtub and tiles to create the bathroom you want.



The lower part of the space is packaged with the advantages of a unit bath, making it easy to choose wall and floor combinations.

The upper part of the space can be finished freely using conventional construction methods, and is recommended for cases with windows and beams. Enjoy coordinating with Sanwa Company's original bathtubs, which are popular for their modern design.

### Wall – Floor Tile

The walls and floors are porcelain tiles with a luxurious feel. You can choose from 3 combinations.

\*The combination of wall and floor tiles cannot be changed.

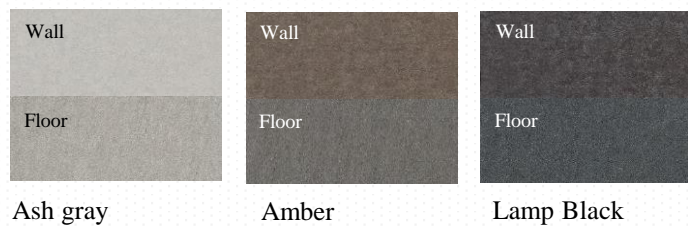

Ash gray

Amber

Lamp Black

### Bathtub

You can combine with sanwacompany's original bathtub "Barca", or "Groovy Eight".



Barca



Groovy Eight

### Bathroom door (Optional)



Swing doors  
Resin surface

Swing door  
Grass surface

Swing door + fix window  
Grass surface



### Half Unit Type Set

Half unit type with a set of floor, waist wall and bathtub.

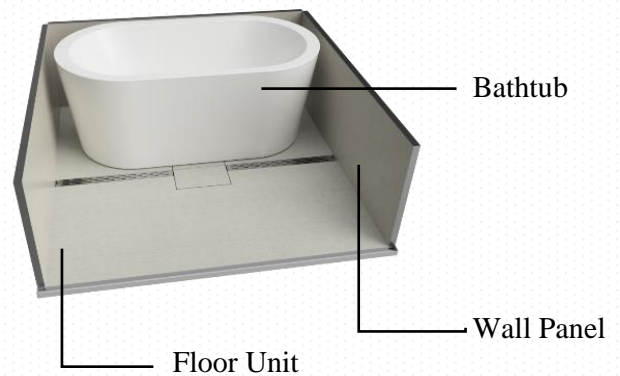

Bathtub

Wall Panel

Floor Unit

- [Size (internal)] 1600 x D1600 x H577 mm (half wall)
- [Bathtub] Pop-up drain plug, with overflow, with/without reheating piping, acrylic, white color
- [Floor] Split structure of floor pan of washing area and bathtub floor pan, porcelain tile (FRP base)
- [Wall] Half-wall, without /with faucet hole,  
※hole position UL-350mm, hole pitch 200mm, porcelain tile (cement board base)
- [Door] Frame: Aluminum,  
Surface material: Resin/toughened glass (with shatterproof film)
- [Country of origin] Japan, China

# Ofree Highback

| System-Bath

Enjoy the best bath time at home, as if you were spending time in the bath space of the hotel. The headrest, which stands up in an organic form, allows you to relax and relax, giving you a sense of security as if you were wrapped up. The inside of the bathtub has a smooth texture that is gentle on the bare skin, and the outside has a matte texture with a high-quality feel. Whether you're soaking in it or looking at it as a space, you'll feel comfortable and satisfied.



Size: W1590 × D800 × H724mm  
Weight: 61kg  
Capacity: 200L  
Body: acrylic



プロダクトデザイナー  
倉本 仁  
Jin Kuramoto

The high-back type of bathtub "Ofree" was shaped with product designer Hitoshi Kuramoto.



# Ofree Pillow

| System-Bath

**A soft form that frees your vision and body.**

Pillow type has a generous curved form that makes you want to touch it. The gently sloping headrest provides moderate support for both head and body. There is no rise as in the high-back type. It is recommended for those who want to refresh themselves with a feeling of openness. The headrest is not raised as in the high-back type. Enjoy a superb moment when both your vision and body are free!



Size: W1600 x D900 x H635mm

Weight: 36kg

Capacity: 195L

Body: Acrylic

(Only the outside has a matte finish)

Legs: Adjustable height with adjuster  
(approximately 10mm)

[Country of origin] China



A seamless fluffy texture is reproduced

# Quadro Slim

| Door

**New additions include bronze frames and ribbed glass, enabling heights of up to 2600mm.**

"Quadro Slim" is an extension of the ancient Japanese sliding door culture. The minimalist design with a 16mm frame and glass inlay creates a connection between spaces and creates a quality atmosphere of unobstructed space. New additions include bronze-colored frames and 'ribbed glass' with texture. Furthermore, customization is now available for ceiling heights up to 2600mm, expanding the possibilities for spatial design.





4 Draws Draw Difference Standard Door Type Frame / Bronze Glass Type / Rib Color / Clear



Discover a slim 16mm frame design. With its top-hanging mechanism, there's no need for a floor rail, creating a sense of spaciousness in the room.



The handle seamlessly integrates with the frame for a sleek design.

■ Frame color

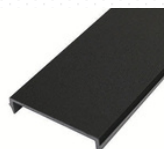

Black



White

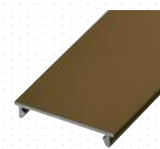

Bronze **NEW**

■ Glass Type



Normal



Clear

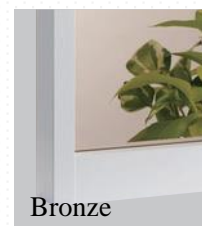

Bronze



Rib **NEW**

■ Infill color



White



Gray

The frame is available in 3 colors, the glass comes in 4 color options, and we offer two surface finishes: the traditional flat type and a new ribbed type.  
 ※ The ribbed type is available in only 3 colors: clear, bronze, and gray.

# Quadro Slim

## Glass partitions of high quality design

"Quadro Slim" is an extension of the ancient Japanese sliding door culture. The minimalist design with a 16mm frame and glass inlay creates a connection between spaces and creates a quality atmosphere of unobstructed space.



# Quadro Slim

It functions as a partition that keeps a delicate sense of distance as if there is a "fusuma" in the same space.

The minimalist design with glass inlaid in a 16mm frame creates a connection to the space and creates a high-quality atmosphere with nothing to shield.

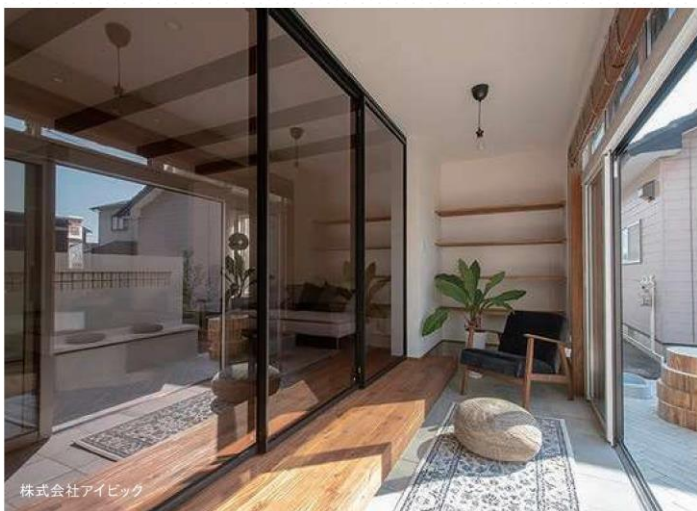

# Variation

## Single-sided door / parent-child door



The frame is made extremely thin, and the handle is designed to integrate seamlessly with the frame. The spacious glass surface is emphasized, maintaining a sense of connection with adjacent spaces. The parent-child door consists of two panels, a regular door and a smaller child door, allowing for a wide entrance when necessary. This design facilitates the easy movement of large furniture and entry/exit for wheelchairs, making it especially recommended for entrances to living rooms.

## Partition Door/FIX



Continuing the tradition of Japan's sliding door culture, these partition doors serve as subtle barriers, allowing for a sense of distance as if there were 'shoji' present in the same space. The newly introduced FIX type maintains an open atmosphere while zoning the space without the need for people to come and go.

### ■ Door Type

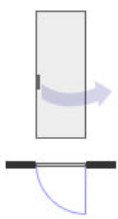

One-sided opening

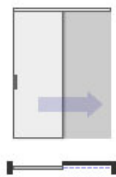

1 sliding door

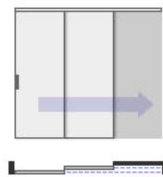

2-panel sliding door.



3-panel sliding door.

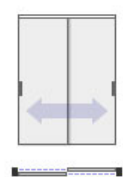

2 Panel - Multi Sliding



Fixed Unit

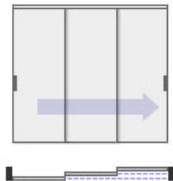

3 Panel - Multi Sliding

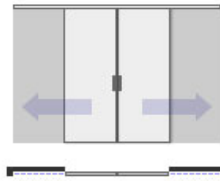

2 Panel - Sliding Bi-part

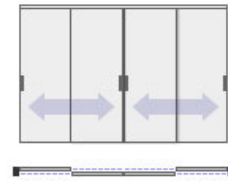

4 Panel - Sliding Bi-part



## Single-sided door / parent-child door



The simple single-hinged door maintains an open feeling with its transparent design, as there are no vertical bars dividing the glass surface. The frame, reaching up to the ceiling and designed to be as slim as possible, enhances the expansive impression of the glass surface.

The parent-child door consists of two doors: a regular door and a child door. The advantage is that the child door can also be opened and closed as needed, creating a wide entrance. It is convenient for moving large furniture in and out and for entering and exiting in a wheelchair, especially recommended for entrances to living rooms. It also excels in light transmission, allowing for a brighter space.



### Single-sided door size

	Standard (DW755mm)	Height Customization
Frame Dimensions	W780×H2350mm	W780mm
		H1800~2500mm Horizontal bar clear: H2100~2500mm
Colors	Clear	Clear
	White/Bronze/Grey	White/Bronze/Gray
	Horizontal Pier Clear	Horizontal Pier Clear

### Single-sided door size

	Standard (DW767+402mm)	Height change
Frame Dimensions	W1190×H2350mm	W1190mm
		H1800~2500mm Horizontal bar clear: H2100~2500mm
Colors	Clear	Clear
	White/Bronze/Grey	White/Bronze/Grey
	Horizontal Pier Clear	Horizontal Pier Clear

● Door damper (body included)



white



black

\* It is necessary to install the ceiling base.

\* The color of the door damper is according to the selected frame color.

● Doorstop



Hook Type



Flat type

## Specifications of Single-sided door size

<b>Standard Sizes (Standard)</b>	Single-sided door: W780×H2350mm, Parent-child door: W1190×H2350mm	
<b>Material</b>	Door frame	Aluminum, sheet (color/black/white)
	Puller	Aluminum, paint finish (color/black/white)
	Door surface material	Made of T5mm glass, shatterproof film attached, shaft hanging closure type
	Door surface color	Clear: T5mm transparent glass, shatterproof film applied (transparent)
		Bronze: T5mm transparent glass, shatterproof film (bronze color)
		White: T5mm transparent glass, shatterproof film (milky white translucent)
		Gray: T5mm transparent glass, shatterproof film applied (gray)
Metal fittings, mounting parts	Steel, Plastic	
Horizontal pier	Aluminum, sheet (color: black, white)	
<b>Door weight</b>	DW755 (1 sheet: approx. 35 kg)	
<b>Mounting method</b>	Three-sided frame specification: fixed to the upper ceiling surface, fixed to the lower wall (fixed to the base of the building tree)	

## Partition Door/FIX



Sliding doors that open like fusuma partitions. Even when left open, they don't obstruct and neatly fit from floor to ceiling. Perfect for dividing spaces as entryways, and also suitable for use as stylish closet doors that showcase storage items elegantly.

Fixed type that can be used as a glass wall in places where no opening is required. It allows zoning of space while maintaining openness and eliminating the need for people to come and go. Depending on the frame and glass color, it's also possible to add accents to the interior. "Quadro Slim" not only serves as a sliding door or a door but also functions as a glass partition to divide spaces. In addition to the existing "FIX type," "FIX connected type" has been added, allowing for connection of 2 to a maximum of 4 panels. This enables the creation of open, spacious areas with a greater expanse, providing a sense of openness.



Unparalleled high-end luxury fittings expand the possibilities of space production

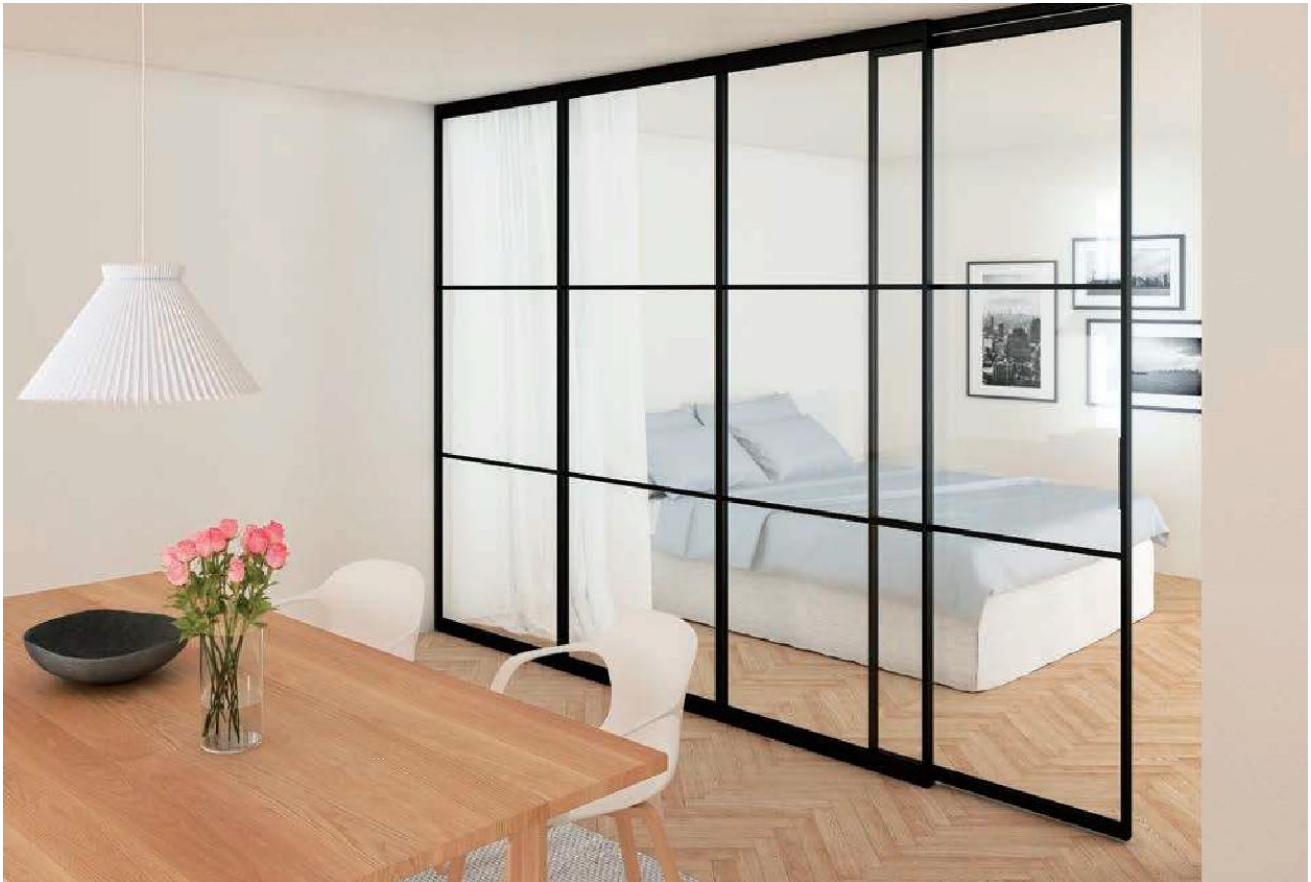

### Quadro Slim Partition Door/FIX Specifications

<b>Standard Sizes (Standard)</b>	H2350×DW803/1200mm	
<b>material</b>	Door frame	Aluminum, sheet (color/black/white)
	Puller	Aluminum, paint finish (color/black/white)
	rail	Aluminum, sheet (color/black/white)
	Door surface material	Made of T5mm glass, shatterproof film
	Door surface color	Clear: T5mm transparent glass, shatterproof film applied (transparent)
		Bronze: T5mm transparent glass, shatterproof film (bronze color)
		White: T5mm transparent glass, shatterproof film (milky white translucent)
		Gray: T5mm transparent glass, shatterproof film applied (gray)
	Metal fittings, mounting parts	Steel, Plastic
Horizontal pier	Aluminum, sheet (color: black, white)	
FIX coupling	Aluminum, painted finish (color: black and white)	
<b>Door weight</b>	DW803 (1 sheet: approx. 33 kg)	
	DW1200 (1 sheet: approx. 46 kg)	
<b>Mounting method</b>	Ceiling surface: Vertical frame for sliding door Vertical frame for sliding door: Fixed to the wall (fixed to the base of the building tree) * Vertical frame for sliding door is optional	

# Noppo

| Door

made in Japan

## Beautifully Enhance Your Space with Industry-Leading 2700mm High Doors“

The "NOPPO" boasts a height that reaches up to the ceiling, a color range that can be coordinated with sanwacompany's storage and other products, and an abundance of item variations.

With heights selectable up to 2700mm, it caters to creating expansive and open spaces. With a wide range of variations and refined designs, it meets all preferences for door fixtures to respond to spatial design needs.



White

Black

Rough Gray



Mortar **NEW**

Grayish wood

White oak

[Door] Olefin sheet pasting  
[Glass] tempered glass thickness 5mm  
[Country of origin] Japan





親子ドア ハイドア スリム枠 スリットガラス/モルタル | クローゼット 折戸 2枚扉 ハイドア/モルタル | 床タイル: ウォーンアンソロ ホワイト

# Noppo

ノッポ

Slim frame and embedded soft closer  
make it even more beautiful and noiseless

The newly introduced Hight - Door specification, reaching a maximum height of 2700mm, responds to the trend of creating open and spacious environments. When the door is closed, its flat "surface" beauty stands out, while the sense of openness when opened is tremendous. Combining it with slim frames enhances the sleek appearance, contributing to a quieter space. And of course, not compromising on fundamental performance and details, the "Hight-Door" ensures reliability. For the glass type, it employs durable 5mm thick tempered glass to minimize breakage, and incorporates iron cores into the structure to prevent warping due to room temperature differences, demonstrating meticulous attention to safety and hidden aspects.



## Soft Closer Type

For slim frame type single-sided doors and parent-child doors, you can now choose a type with an inconspicuous recessed soft closer.



片開きドア スリム枠 フラット/ホワイト

Door - Noppo

When comparing the standard heights of 2100mm and 2400mm for the 'Noppo' door, the difference in feeling of openness is obvious. The high-door version allows for a more expansive space

\*When using slotted glass, designs with frames above and below the glass are implemented for heights exceeding 2400mm.

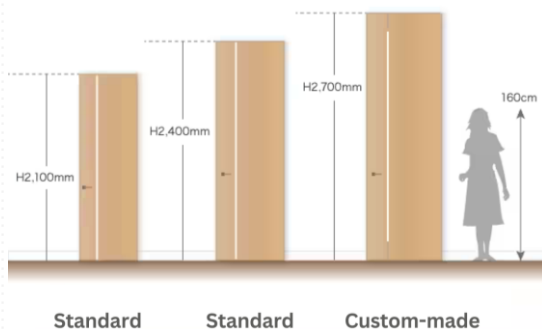

**The slim frame creates a noiseless space with its thin 11mm profile.**

The 'Noppo', capable of accommodating up to 2700mm in height, is a minimalistic design that values the beauty of spacious 'surfaces'. Enhancing its charm further is the introduction of the slim frame type. Achieving a thickness of only 11mm for the frame, as opposed to the usual 20mm or more, accentuates the door's veneer and creates a sleek ambiance by minimizing the presence of the frame to the utmost extent

\* The recommended fit of the slim frame is as follows.

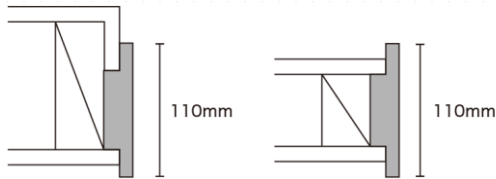

Door – Noppo

**Variation**



Single swing door/ parent-child door  
( Single swing door with an active sidelight)

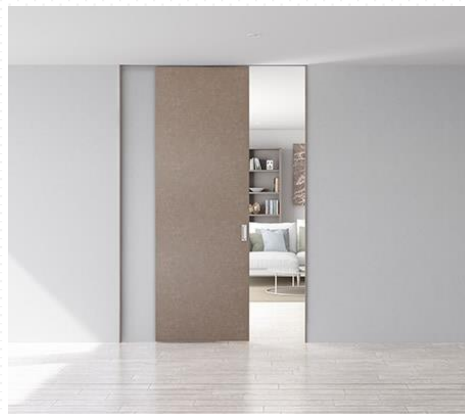

Single sliding door



Outward Sliding Door

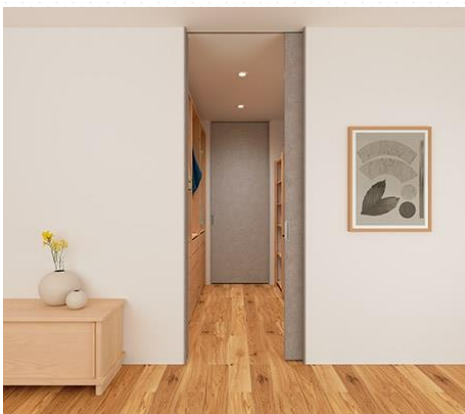

Pocket (inwall) sliding door



Partition Door



Closet Door



◆ **Single-hinged doors and Parent-child door**

**Specification**

<b>Size</b>	Height	2100/2400mm
	Width	Frame: 650, 735, 755, 780, 825, 850, 875, 1190mm
<b>Color</b>		Mortar, Black, Rough Gray, Grayish wood, White, White Oak
	Door	Olefin sheet MDF (surface) [ LVL/MDF/Particleboard (core) ]
<b>Finishing touches</b>	Frame	MDF
	Glass	Tempered glass (heat treatment) Thickness 5mm * Frosted glass has a front and back.
<b>Soft-close function</b>		None * However, it is available with the option "door damper specification".
<b>Set Contents</b>		Doors, frames, door handles, number, mounting hardware



Door – Noppo

● **Single-hinged doors type**



Flat



Slit glass (clear)



Slit glass (Frosted)



Wide Glass (Clear)



Wide Glass (Frosted)

● **Noppo Parent-child door (Single swing door with an active sidelight)**



Flat



Slit glass (clear)



Slit glass (Frosted)



Wide Glass (Clear)



Wide Glass (Frosted)

Option	
Frame Forecast Change	Single-hinged doors
	Parent-child door
Height change	Single-hinged doors
	Parent-child door
Built-in lock mug change 	Single-hinged doors
	Parent-child door
Recessed dampers	Single-hinged doors
	Parent-child door



● **Frame**

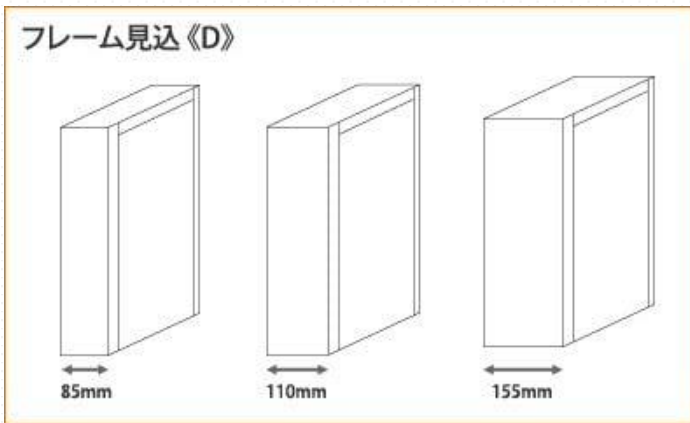

\* Frame estimate "D" can be selected from 85mm, 110mm, and 155mm.

\* Slim frame is available only in D110.

\* The recommended fit of the slim frame is as follows.

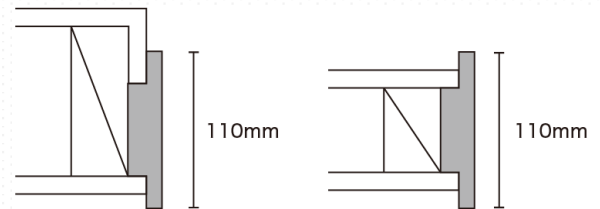

● **Handle**

Standard



N-1 Maruza Silver



N-1 Maruza Black

Standard



N-2 Maruza Silver



N-2 Maruza Black



N-1 Kakuza Silver



N-1 Kakuza Black



N-2 Kakuza Silver



N-2 Kakuza Black

## ◆ Sliding Door

### Specification

Size	Height	2100/2400mm
	Width	1190, 1450, 1645, 1745mm
Color		Mortar, Black, Rough Gray, Grayishwood, White, White Oak
Finishing touches	Door	Olefin sheet MDF (surface) [ LVL/MDF/Particleboard (core) ]
	Frame	MDF (vertical frame) / LVB / plywood (Kamoi)
	Glass	Tempered glass (heat treatment) Thickness 5mm * Frosted glass has a front and back
Soft-close function		Die-cast aluminum paint finish
Set Contents		None * However, it is supported by the optional "W soft close specification"



片引き戸 スリム枠/ラフグレー

### ● Sliding doors Type



Flat



Wide Glass (Clear)



Wide Glass (Frosted)

### ● Frame

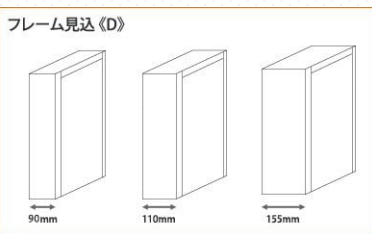

\* The frame estimate "D" can be selected from 90mm, 110mm, and 155mm.

\* Slim frame is available only in D110.

### ● Puller

Standard



Silver



Black



With Lock Silver



With Lock Black

## ◆ Outward Sliding Door

### Specification

Size	Height	2070/2370mm (2068/2368mm floor rail type, with soft close, with imposition rail)
	Width	713, 813, 913mm
Color		Mortar, Black, Rough Gray, Grayishwood, White, White Oak
Finishing touches	Door	Olefin sheet MDF (surface) [ LVL/MDF/Particleboard (core) ]
	Frame	MDF
	Glass	Tempered glass (heat treatment) Thickness 5mm * Frosted glass has a front and back. For more information, please contact.
	Rail	Aluminum extrusion anodized paint finish
	Puller	Die-cast aluminum paint finish
	Outset sliding door lock (frameless)	Zinc alloy paint finish
Soft-close function		Upper rail type: Yes Floor rail type: None * With brake function / Yes Soft close is a W soft close specification.
Set Contents		Door body, hardware (rails, outset hardware, empty lock puller)



### ● Outward Sliding doors Type



Flat



Wide Glass (Clear)



Wide Glass (Frosted)

### ● Puller

Standard



Silver



Black



With Lock Silver



With Lock Black

### ● Rail

Standard



### ● Soft-close Rail

Standard



## ◆ Pocket (inwall) sliding door

The in-wall sliding door, which has been newly added to the sliding door variation, stores the open sliding door neatly in the door bag. The room looks larger, so it is recommended if you usually leave it open. In addition, even if it is open, the sliding door does not get in the way, so there is a high degree of freedom in the placement of furniture and other items. As an option, we also offer a wall panel set that can be easily installed.

Simplified construction of sleeve walls in the door bag  
 Wall panels are available as an option. You can easily install a sleeve wall for a door bag.  
 Since we use LVL (veneer laminate) with an iron core, warping is also considered.

\* Wall panels can be used up to a ceiling height of 2400 mm.

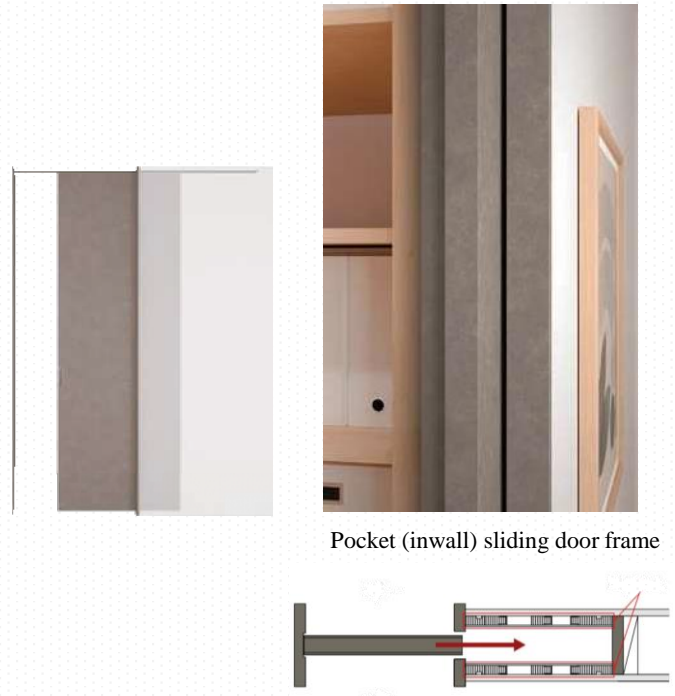

Pocket (inwall) sliding door frame

## ◆ Pocket (inwall) sliding door

### Specification

<b>Size</b>	Height	2100/2400mm
	Width	1190, 1450, 1645, 1745mm
<b>Color</b>		Mortar, Black, Rough Gray, Grayishwood, White, White Oak
<b>Finishing touches</b>	Door	Olefin sheet MDF (surface) [ LVL/MDF/Particleboard (core) ]
	Frame	MDF (vertical frame) / LVB / plywood (Kamoi)
	Glass	Surface material: Double-sided MP sheet pasted MDF Core material: 40mmLVL, 24mmLVL (Reinforcement: steel channel)
<b>Soft-close function</b>		Die-cast aluminum paint finish
<b>Set Contents</b>		W Soft Close Specification

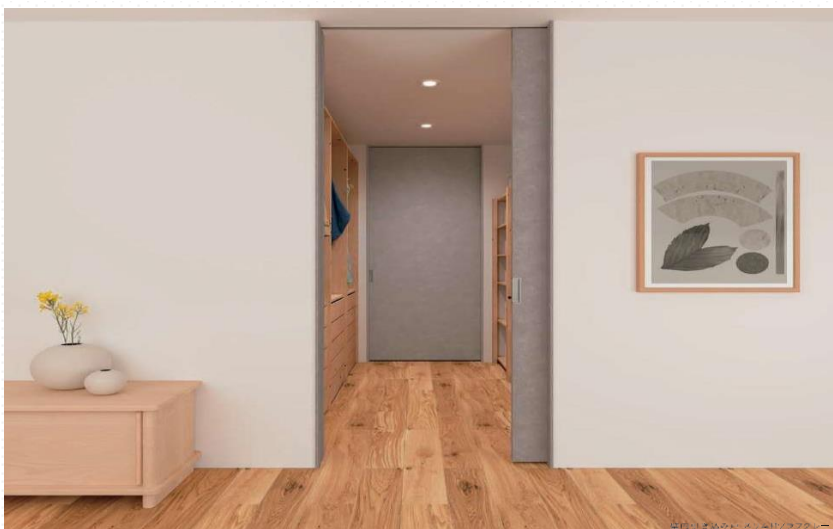

### ● Sliding doors Type



### ● Frame

\* The estimated frame "D" is only 155mm.

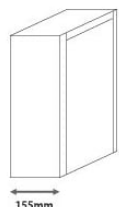

## ◆ Partition door

### Effective Use of Space with Sliding Doors

Japanese fusuma doors ( sliding doors) are excellent as movable partitions. When closed, they create separate spaces, and when open, they provide an open and spacious area. For creating versatile spaces, we recommend the tall, sliding doors reminiscent of fusuma. Being top-hung, they are barrier-free without rails on the floor, allowing for easy cleaning and enabling robotic cleaners to work smoothly.



2 Panel - Sliding Bi-part White  
W3248×H2400mm



2 panel sliding door Grayish wood  
W2465×H2400mm



3 panel sliding door White  
W3215×H2400mm



# Mr.DELICATO

| System storage

made in Japan

It is a stylish storage system that changes its expression depending on the individuality of the person who uses it. By freely arranging shelves and boxes on the aluminum pole, you can design the storage itself. It can be used not only as wall storage but also as a room divider as it can be used from both sides. Enjoy storage that will become the leading role in your interior with your favorite combination in your favorite place.



# Mr.DELICATO



Aluminum shelfIt is a shelf board with a sharp design that eliminates unnecessary lines to the limit.

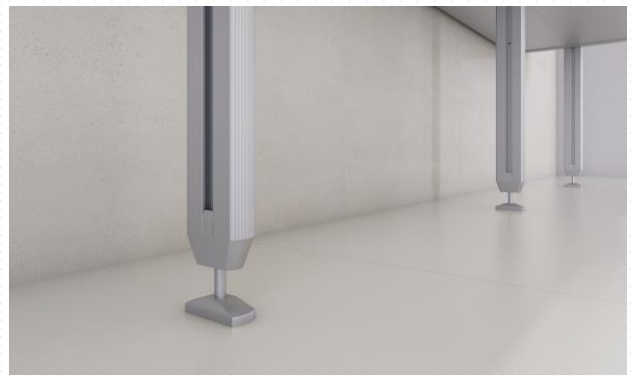

Aluminum pole  
3 different heights of 2350/2550/2700mm according to application. \*Two types of partitions are available.



Aluminum cabinet, available in 3 types: drawer/single-sided flap/double-sided flap. The acrylic panel on the door creates a stylish space.



Pipe hanger  
A pipe hanger made of the same material as the aluminum pole creates a closet with a sense of unity.

<b>Size</b>	Ceiling height: 2350/2550/2700mm, standard width for each part: 800/1200mm
<b>Material</b>	
Aluminum Pole	Aluminum anodized aluminum extruded material (silver), leg adjuster type, metal fittings made by UNIQLO, resin cover (silver)
Aluminum Shelf	Aluminum alumite extrusion material (two-part integrated type), Fixing bracket: UNIQLO (silver)
Aluminum cabinet Drawer Type	Aluminum anodized aluminum extrusion (silver), 1 drawer rail, wooden bottom plate
Aluminum cabinet Single-sided flap type	Aluminum anodized aluminum extrusion (silver), downstay fittings, 1 shelf included
Aluminum cabinet Double-sided flap type	Aluminum anodized aluminum extrusion (silver), downstay fittings, 1 shelf included
Pipe hanger	Aluminum anodized extruded material (silver)



# Mr.DELICATO PART LIST

	Code No.	Part Name	Size	Color
	CL07036	2350 for aluminum pole partition (set of 1)	CH=2350mmFor partitions	Silver
[No Image]	CL07037	2350 for aluminum pole partition (set of 2)	CH=2350mmFor partitions	
	CL07038	2550 for aluminum pole partition (set of 1)	CH=2550mmFor partitions	Silver
[No Image]	CL07039	2550 for aluminum pole partition (set of 2)	CH=2550mmFor partitions	
	CL07024	Aluminum Cabinet Double Sided Flap Type W1200	W1193×H252×D475mm	Silver
	CL07014	Aluminum Cabinet Double Sided Flap Type W800	W793×H252×D475mm	Silver
	CL07022	Aluminum Cabinet Drawer Type W1200	W1193×H252×D437.5mm	Silver
	CL07012	Aluminum Cabinet Drawer Type W800	W793×H252×D437.5mm	Silver
	CL07023	Aluminum Cabinet Single Sided Flap Type W1200	W1193×H252×D439mm	Silver
	CL07013	Aluminum Cabinet Single Sided Flap Type W800	W793×H252×D439mm	Silver
	CL07001	Aluminum Pole for Wall 2350 (Set of 1)	CH=2350mmwall-mounted	Silver
[No Image]	CL07031	Aluminum Pole for Wall 2350 (Set of 2)	CH=2350mmwall-mounted	
[No Image]	CL07035	Aluminum Pole for Wall 2700 (Set of 2)	CH=2700mmwall-mounted	
	CL07032	Aluminum pole wall mount 2550 (set of 1)	CH=2550mmwall-mounted	Silver
[No Image]	CL07033	Aluminum pole wall mount 2550 (set of 2)	CH=2550mmwall-mounted	
	CL07034	Aluminum pole wall mount 2700 (set of 1)	CH=2700mmwall-mounted	Silver
	CL07021	Aluminum shelf W1200	W1194×D400×t12mm	Silver
	CL07011	Aluminum shelf W800	W794×D400×t12mm	Silver
[No Image]	CL07042	Horizontal wall reinforcement screws	Trust stapping screw L=45mm 10pcs	
	CL07025	Pipe hanger W1200	Elliptical pipe 30×15×L=1193mm	Silver
	CL07015	Pipe hanger W800	Elliptical pipe 30×15×L=793mm	Silver
[No Image]	CL07040	Pole reinforcement bracket set	W12×L=260×t6mm	
[No Image]	CL07041	Wall fixing bracket set	W8.5×20.5×t4mm	

# Pittala

| Custom-made storage

made in Japan

**New models with drawers and casters - everywhere in your home, it's a perfect fit with 'Pittara'.**

Adding to our customizable storage solutions with 1mm precision, we introduce a new type of 《Pittala》 .

The pull-out drawer type, known as 〈Drawer〉 , is perfect for combining with countertops in washroom spaces or aligning with TV units in the living room.

The 〈Move〉 variant, equipped with movable caster wheels, is suitable not only for washroom areas but also fits perfectly under desks in workspaces, serving as a mobile storage unit. Additionally, we have revamped the color variations, incorporating two trendy shades for a refreshed look.



# Pittala



## ■ Specifications

【Body, Door, Shelf】Olefin Sheet  
 【Handle】Push open specification  
 【Country of origin】Japan

## "Destroy" and "decorate" to realize the storage you envision in the ideal form

We will respond exactly to the storage you envision with a semi-order. The biggest attraction is that the width can be ordered in units of 1 mm between 450 mm ~ 1800 mm. In addition, the height and depth can be selected from 4 types, and it is also compatible with the float type. Please use it in various scenes for storage that becomes the main role in the living room and for storing a little dead space.

- Width W450~1800mm, can be ordered in 1mm increments
- Height and depth can be selected from 4 types each, and float type is also supported.
- The counter, side panel, and bottom panel are all 7 mm thick.

## ■ Color variations



Two new wood grain colors to our seamless single-tone palette for a fresh trend. Options include White, White Oak, and Greyish Wood, perfect for coordinating with our 'Noppo' doors. With 8 colors available, mix and match freely for both functional and decorative storage solutions, adding a playful touch to your walls.



# Pittala

## Pittala Hinged door type



Furniture-like cupboard with a depth of 500mm for the kitchen

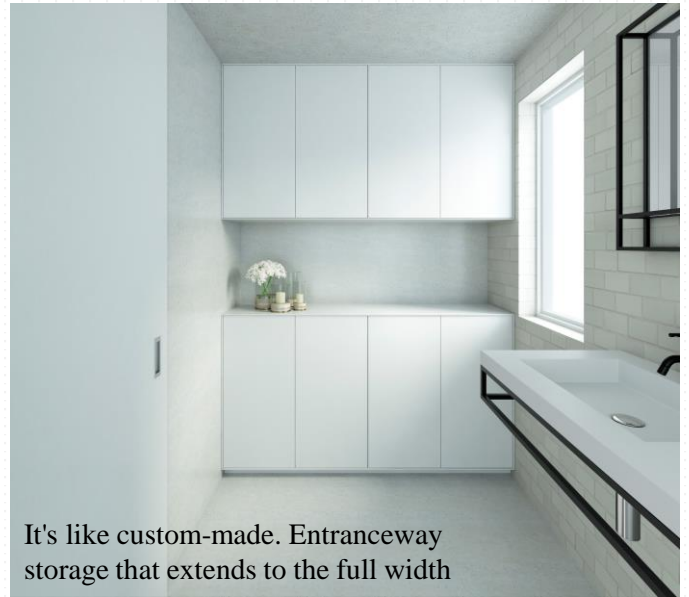

It's like custom-made. Entranceway storage that extends to the full width

## Pittala Drawers Type NEW



W400~900: 1 drawer



W901~1800: 2 drawers



H600: 2 drawers



W1300×H400×D600

The specifications of the drawer vary depending on the size, allowing you to choose the number and height of drawers according to the items you want to store. The interior color of the drawers is uniformly gray, making it easy to see stored items.

## Pittala Move (on casters) NEW



Featuring casters for added versatility, the Move storage unit enhances functionality. Its smooth mobility makes it convenient for cleaning tasks as well. The two-tiered drawers, with adjustable depths, boast a sleek push-open design on the front. The bottom casters are discreet and include locking mechanisms for stability.

# Pittala

## Expanding the world of Pittala, TV Board and Tall Type

The 〈TV Board〉 features a front door with a mesh design that allows infrared signals to pass through for remote controls and similar devices. With the same coloring as regular Pittala storage units, it can create a unified space. The 〈Tall Type〉, addressing popular demand, boasts a maximum height of 1800mm, providing ample storage space. It can be combined with washbasin counters or used as unique storage units to adorn living room walls.

### TV Board



Floating wall storage for “attractive storage”

The color of the mesh door is coordinated with a color that harmonizes with the face material.



White



Why Oak



Misty Wood  
NEW



Grayish wood  
NEW



Black



Gray



Greige



Smoke Green

## Pittala TV board (hinged door)

W900 mm

(Number of doors: 1 mesh door)



W1200~1350 mm

(Number of doors: 1 mesh door, 1 wooden door)



W1351~1799mm

(Number of doors: 1 mesh door, 1 wooden door)



W1800mm

(Number of doors: 2 mesh doors)



1. Mesh door made of metal that allows infrared transmission
  2. Easy-to-use flap-down door (push latch type)
  3. Wiring holes and wiring hole caps for passing equipment cords
- ※ Choice of with or without wiring holes available.
  - ※ Wiring holes are located on the top and bottom surfaces.
  - ※ Wiring hole caps are available in three colors matching the main body color.

[Main body/door/shelf board] Olefin sheet pasted, metal mesh (TV board door only)  
 [Handle] Push open specification  
 [Load capacity]  
 Drawer: Upper shelf/8kg, Lower shelf/12kg,  
 Shelf board (bottom board): 8kg/sheet  
 Top board:  
 ● W250~900mm D200mm/8kg, D300mm/10kg, D400/500mm/15kg  
 ● W901~1800mm D200mm/15kg, D300mm/20kg, D400/500mm/30kg  
 [Country of origin] Japan

## Pittala Tall (Swinging Door)



It is also ideal as a large-capacity storage in the washroom space.  
 It fits neatly into the space.

# Pittana

| Custom-made shelves

made in Japan

**A single shelf for a tidy and neatly displayed storage solution.**

"Pittana" is a coordinated storage product with "Pittala" that can be easily ordered, and it is a single shelf that can be customized in size by 1mm increments. The thickness when viewed from the front is only 7.5mm. With a sleek design where only a thin board appears to float, you can easily increase storage space with a display-like feel.



GOOD DESIGN  
AWARD 2021

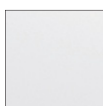

White

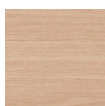

White Oak



Misty Wood  
NEW



Grayish wood  
NEW

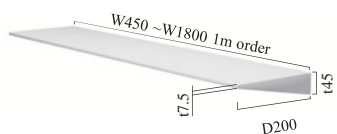

Black



Gray



Greige



Smoke Green

[Body] Olefin sheet pasted  
[Load capacity] W450-899mm: 10kg  
W900-1199mm: 15kg  
W1200-1800mm: 20kg  
[Country of origin] Japan



# Exterior

エクステリア



# Acquretta

| Outdoor/Slop Sink

made in Japan

## Sleek Slope Sink with a Pursuit of Beauty

A slop sink that allows you to wash anything without worry is a versatile addition to both indoor and outdoor spaces such as balconies, gardens, and laundry rooms. The 'Acquretta' sink boasts a simple and elegant design, characterized by flat surfaces and straight lines typically difficult to achieve with ceramics, along with the industry's thinnest profile. Additionally, it features minimal dimensions and thoughtful placement to maximize usability and fit into any space, while its square form appears to float due to the concealed rear mounting. These meticulous details, previously unseen in slop sinks, ensure that even when not in use, it seamlessly blends into everyday life with beauty.



ACQ001P P-Trap Set  
ACQ001S S-Trap Set

W408 × D429 × H290mm  
Made of ceramic  
With overflow  
Capacity: 14L  
Max bowl depth: 230mm  
Accessories: Back fixing bracket  
Country of origin: Japan

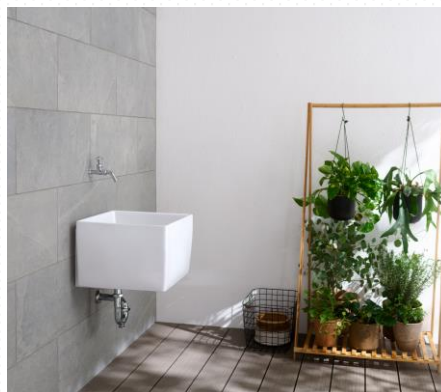
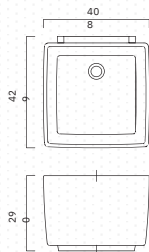

Compact in size to avoid feeling cramped in the space, yet ensuring ample depth for thorough washing. The position of the rubber plug is designed to be hidden behind when not in use.

Faucet fittings

GOOD DESIGN  
AWARD 2023

if DESIGN  
AWARD  
2024



Single Letter Handle  
Garden Faucet  
EX15159



Stick Wall Mixer  
Faucet S Matte Black  
TA05369

# Plameub

| Outdoor/Indoor Storage Shed

made in Japan

A stylish storage shed with lockable door, high weather resistance powder coating that can be used outdoors or indoors. There are many aspects that make this shed stand out from the crowd, including its modern and trendy design.



ブルーグレー

The slim size makes it easy to place in backyards or entrance of detached houses as well as on balconies.



Open door for easy loading and unloading and a clean look. The depth is set to be easily aligned with water heaters, outdoor units, garden pans, etc.,

Two color variations are available with the trend in mind. Both are stylishly finished with a matte texture and low sheen.



Black



Blue-gray

# Pendino

| Gardening Sink

made in Japan

Multi-functions of gardening workbench + sink + storage “PENDINO” makes the time you spend enjoying your hobbies in the garden or on the terrace even more comfortable!

With a sleek, furniture-like design, PENDINO blends in with the interior of your garden or terrace.



Open Type



Storage Type



The sink has a shallow, single-sloped shape that can also function as a workbench. Its wide size makes provides a great space to prepare ingredients or wash barbecue net...



Option:



Draining plate  
W198xH18.7xD365mm

Faucet



# Mini Gabion

| Gardening Goods/ Outdoor Goods

Not only on the outside, but also indoors, how to use it depends on the idea

"Gabion" is a mesh basket filled with natural stones and it has been used for river revetments. In recent years it has also attracted attention for the exterior of houses. sanwacompany commercialized it as one of the garden tools for customers. The expression changes depending on what you put inside, so you can enjoy creating a unique space according to the purpose, such as stone walls, gateposts, and green pots.



## Blend in with the plants to create a natural ambiance

For instance, they can be filled with natural stones and utilized as fences or retaining walls. This creates a pleasantly rustic feel and harmonizes well with nearby plantings. Additionally, ideal split chestnut stones are available separately for filling. Moreover, aside from stones, they can also be filled with firewood or similar materials, serving as both a decorative element and a storage space.





**Great item for also indoor and outdoor activities such as camping.**

In addition to the appearance of the exterior, it can be used as a barbecue table when camping, as a table, stool, planter cover, magazine rack, etc. The beautiful stainless steel finish blends well with the interior, and the corners are bent for safety.

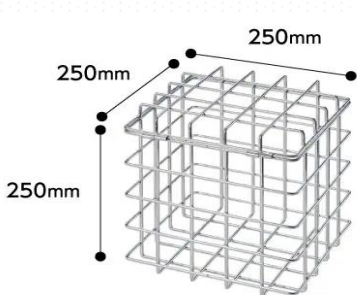

**Mini Gabion 250**  
EX09219  
W250xD250H250mm

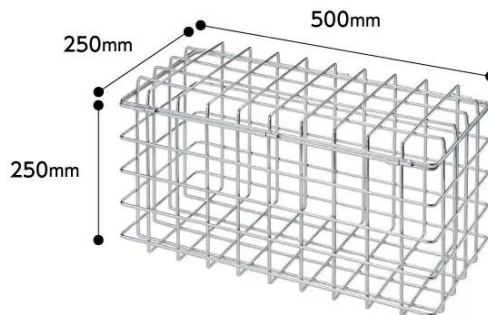

**Mini Gabion 500**  
EX09219  
W250xD250H250mm



Option:  
Stone for Mini Gabion  
EX09239

[Material]: ø4 mm stainless steel wire (SUS304)  
 [Accessory] Stainless steel cotter pin (for fixing lid)  
 [Load capacity] 250: 80 kg (when stone is loaded)  
 500: 160kg (when stone is loaded)  
 [Country of origin] Taiwan

# Ostrape

| Gatepost

made in Japan

Can be installed anywhere

Noiseless function gatepost with hidden functions

The "Ostrape" functional gatepost has a beautiful appearance that makes the presence of the intercom and mailbox virtually invisible. The trapezoidal cross-section allows for installation in places with narrow depths and smooth access to mail from the side. The flat design without any unevenness and the high-quality matte black finish harmonize with the facade of any house.

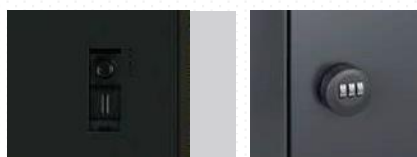
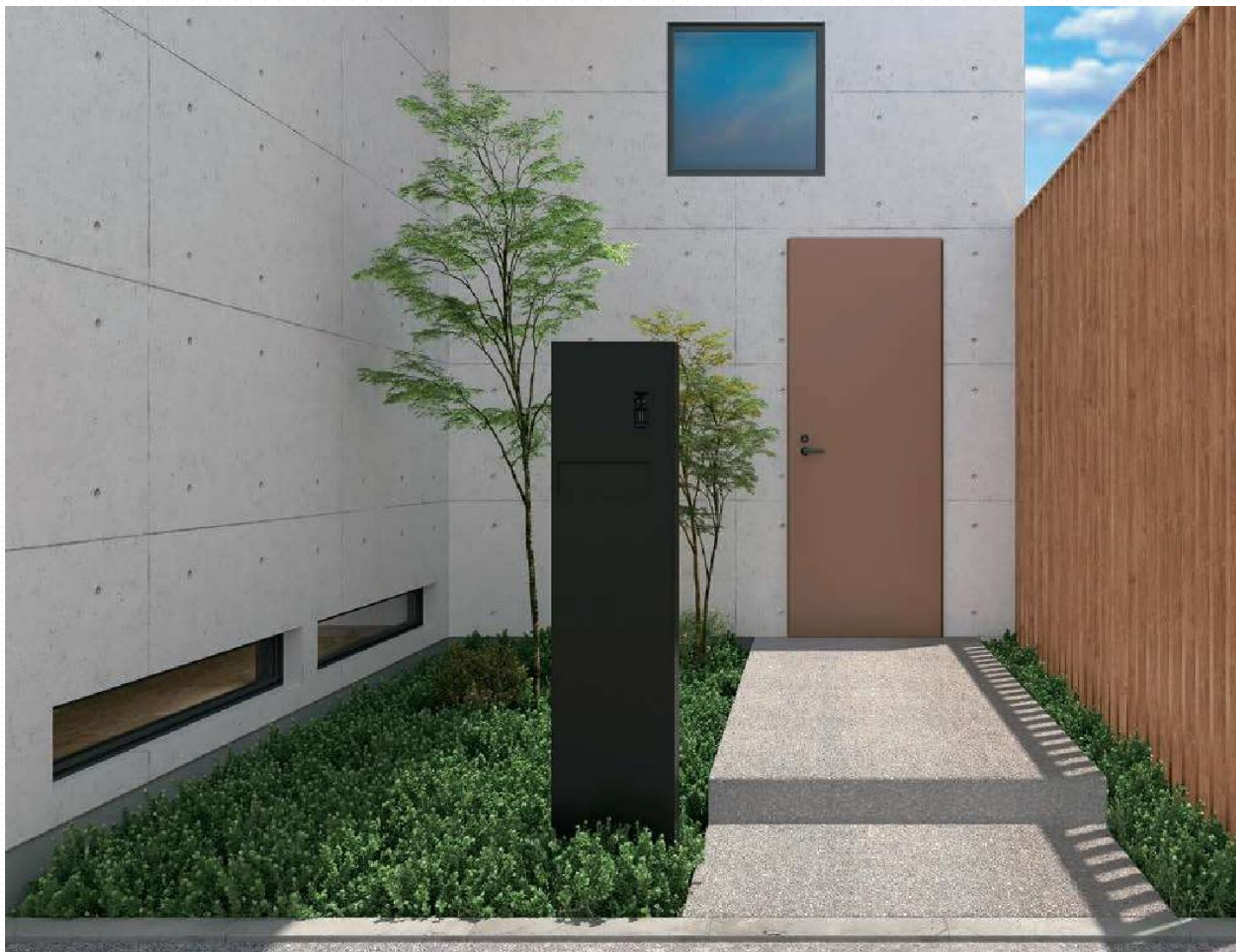

Neat-looking  
built-in intercom

Dial lock matches  
the body color

The trapezoidal design, viewed from above, provides an angle that makes it easy to retrieve mail from the approach without having to go around. Since the door is not visible from the street side or from the side, it is safe and secure without alerting the public to the presence of mail.

OSTRAPE  
EX21001 Right-hung for take-out  
EX21011 Left-hung for take-out

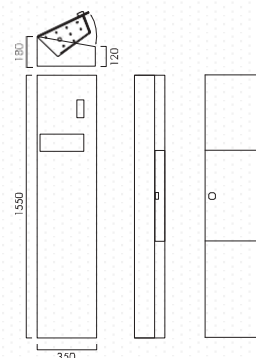

# Ospole

| Gatepost

made in Japan

## Seamless functional gatepost in pursuit of simple modernity

This functional gatepost integrates basic functions such as a built-in intercom as well as a post box. The seamless design, with minimal waste, blends in with the exterior of any home while subtly asserting its presence. The "OSPOLE," which utilizes the material feel of stainless steel as it is, and the "MATTE BLACK" and "MATTE WHITE," which have a low luster texture, are also available to coordinate with the entrance door and eaves.



Ospole



Matte White



reddot award 2017  
winner





Seamless and beautiful design



A4-compatible post with accompanying



View of the take-out port

Model	Ospole	Ospole Matte White	Ospole Matte Black
Right side	EX07009	EX07039	EX07059
Left side	EX07019	EX07049	EX07069

[Size] W150 x D300 x H1500 mm (excluding the part buried underground) [Material] Ospole: Stainless steel (SUS304)  
 Ospole matte white/black: Steel plate (SUS304 on the back)  
 [Finish] Ospole: Hairline finish  
 Matte white and matte black: Powder coating

- Vertical post box with front insert/reverse insert
- With a dial lock
- Intercom built-in installation type (intercom sold separately.)
- Name stickers, etc. are to be arranged by the customer.

[Country of origin] Japan



オスポールマットホワイト

### Slim type with post function separated

《OSPOLE SLIM》 is recommended for those who wish to have a mailbox near the front door. Eliminates the post function for a slimmer design. It blends in with the surrounding environment and enhances the exterior space at the entrance. This post can also incorporate a commercially available intercom, integrating the basic functions of the post.

**Ospole Slim**  
 EX07029 Ospole Slim  
 EX07141 Matte White  
 EX07151 Matte Black





# Ospole Delivery Box

| Delivery Box

made in Japan

**A smart delivery box that receives packages on behalf of the family**

The "OSPOLE Delivery Box" combines an intercom panel, a mailbox, and a box for receiving parcels even when you are not at home. It is recommended for families that go to work or are frequently away from home. It is available in three colors: stainless steel, matte white, and matte black. The sophisticated design of the OSPOLE series creates a clean entrance area without making the presence of the delivery box felt.



ページ

Matte White, Matte Black:





オスポール宅配BOX



Turn the red knob to the right to lock it, and then close the door.



It can be taken out with the attached key. Unlock the door with the key, take out package, confirm that the indicator has turned green, and close the door.

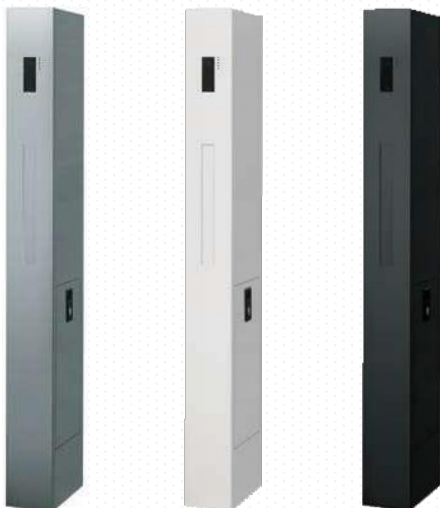

Model	Ospole Delivery box	Matte White	Matte Black
Right side	EX07079	EX07101	EX07121
Left side	EX07089	EX07111	EX07131

[Size] W150 x D300 x H1500 mm (excluding the part buried underground)  
 [Delivery box inner dimensions] Door frontage dimensions: W204 x H461 mm  
 Recommended maximum size for receiving: W204 x D135 x H376

[Material] Ospole : Stainless steel (SUS304)

Ospole matte white/black: Steel plate (SUS304 on the back)

[Finish] Ospole: hairline finish, matte white/matte black: powder coating

- Vertical post front in/out
- With dial lock
- Built-in intercom installation type
- Customers are responsible for name stickers.

[Country of origin] Japan

# Osboard

| Intercom Cover

made in Japan

## Minimalist wall-mounted intercom cover comes in a single board

The entrance of a house has many components such as the entrance door, nameplate, mailbox, and intercom, making it difficult to unify the design. For those who has that feeling, Osboard is recommended.

The three functions necessary for an entrance - intercom, post, and nameplate - can be beautifully integrated into a single unit.

The square form stands out for its flat, floating and slim design is a perfect match to the existing "#Bretta" mailbox.



The square form stands out for its flat “surface” and the beauty of its paintwork. It looks like a single plate, and the size of the openings that allow the camera, microphone, and buttons to function has been minimized.



White  
EX17059



Black  
EX17069



Silver  
EX17079



Mortar  
EX17089



Rusty Red  
EX17099



Blue-green  
EX17109

Size: W405xH202xD60mm  
Material: Stainless steel (SUS430)  
Country of Origin: Japan

# Bretta

| Mailbox

made in Japan

## Minimal design that looks like a single board

The "Bretta" has been stripped of all functions other than those necessary for a mailbox, so that the lock and mail slot are not visible from the front, giving it a clean, single-panel look. A total of six colors are available, including basic and trendy colors for the exterior. There is enough space inside for an A4-size envelope. It blends neatly into the exterior and creates a minimalist space without waste.

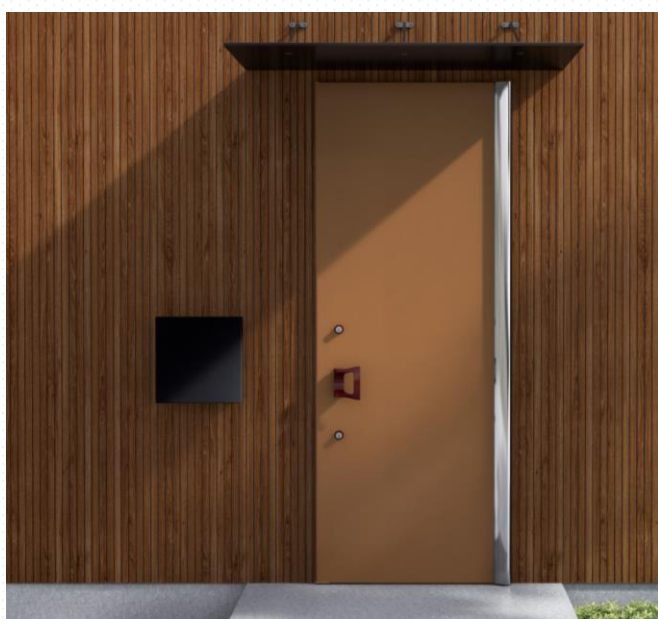

White  
EX01709



Black  
EX01719



Silver  
EX01729



Mortar  
EX01919



Rusty Red  
EX01929



Blue-green  
EX01939

Size: W405xH405xD106mm/ W292xD28mm (input port)  
Material: Stainless steel (SUS430)  
Country of Origin: Japan



SHOWROOM

SAPPORO  
(SMART SHOWROOM\*)

Yokohama

Osaka

Sendai

Fukuoka

Tokyo

Nagoya